

# CRD50

## V2.00



[www.philips.com/welcome](http://www.philips.com/welcome)

User Manual (English)

**PHILIPS**  
**Signage**Solutions

# Safety Instructions

## Safety precautions and maintenance



**WARNING:** Use of controls, adjustments or procedures other than those specified in this documentation may result in exposure to shock, electrical hazards and/or mechanical hazards.

### Read and follow these instructions when connecting and using your OPS Module:

#### Operation:

- Keep the OPS Module out of direct sunlight and away from stoves or any other heat sources.
- Remove any object that could fall into ventilation holes or prevent proper cooling of the OPS Module's electronics.
- Do not block the ventilation holes on the cabinet.
- When positioning the OPS Module, make sure the power plug and outlet are easily accessible.
- When turning off the OPS Module by detaching the power cord, wait 6 seconds before re-attaching the power cord for normal operation.
- Ensure the use of an approved power cord provided by Philips at all times. If your power cord is missing, please contact your local service center.
- Do not subject the OPS Module to severe vibration or high impact conditions during operation.
- Do not knock or drop the OPS Module during operation or transportation.
- For doors or covers intended to be removed by operator for installation of accessory devices. Instructions shall be provided for the correct removal and reinstallation of the door.

#### Maintenance:

- Unplug the OPS Module if you are not going to use it for an extensive period of time.
- Unplug the OPS Module if you need to clean it with a slightly damp cloth. The screen may be wiped with a dry cloth when the power is off. However, never use organic solvent, such as, alcohol, or ammonia-based liquids to clean your OPS Module.
- To avoid the risk of shock or permanent damage to the set, do not expose the OPS Module to dust, rain, water or an excessively moist environment.
- If your OPS Module becomes wet, wipe it with dry cloth as soon as possible.
- If a foreign substance or water gets in your OPS Module, turn the power off immediately and disconnect the power cord. Then remove the foreign substance or water; and send the unit to the maintenance center.
- Do not store or use the OPS Module in locations exposed to heat, direct sunlight or extreme cold.
- In order to maintain the best performance of your OPS Module and ensure a longer lifetime, we strongly recommend using the OPS Module in a location that falls within the following temperature and humidity ranges.
  - Temperature: 0-40°C 32-104°F
  - Humidity: 20-80% RH

#### Service:

- The casing cover should be opened only by qualified service personnel.
- If there is any need for repair or integration, please contact your local service center.
- Do not leave your OPS Module under direct sunlight.



If your OPS Module does not operate normally, having followed the instructions set out in this document, please contact a technician or your local service center.

## Read and follow these instructions when connecting and using your OPS Module:



- Unplug the OPS Module if you are not going to use it for an extensive period of time.
- Unplug the OPS Module if you need to clean it with a slightly damp cloth. The screen may be wiped with a dry cloth when the power is off. However, never use alcohol, solvents or ammonia-based liquids.
- Consult a service technician if the OPS Module does not operate normally when you have followed the instructions in this manual.
- The casing cover should be opened only by qualified service personnel.
- Keep the OPS Module out of direct sunlight and away from stoves or any other heat sources.
- Remove any object that could fall into the vents or prevent proper cooling of the OPS Module's electronics.
- Do not block the ventilation holes on the cabinet.
- Keep the OPS Module dry. To avoid electric shock, do not expose it to rain or excessive moisture.
- When turning off the OPS Module by detaching the power cable or DC power cord, wait for 6 seconds before re-attaching the power cable or DC power cord for normal operation.
- To avoid the risk of shock or permanent damage to the set do not expose the OPS Module to rain or excessive moisture.
- When positioning the OPS Module, make sure the power plug and outlet are easily accessible.

## EU Declaration of Conformity

This device complies with the requirements set out in the Council Directive on the Approximation of the Laws of the Member States relating to Electromagnetic Compatibility (2014/30/EU), Low-voltage Directive (2014/35/EU), RoHS directive (2011/65/EU) and Radio Equipment Directive (2014/53/EU).

This product has been tested and found to comply with the harmonized standards for Information Technology Equipment, these harmonized standards published under Directives of Official Journal of the European Union.

### Warning:

This equipment is compliant with Class A of EN55032/CISPR 32. In a residential environment this equipment may cause radio interference.

## Federal Communications Commission (FCC) Notice (U.S. Only)



**NOTE:** This equipment has been tested and found to comply with the limits for a Class A digital device, pursuant to part 15 of the FCC Rules. These limits are designed to provide reasonable protection against harmful interference when the equipment is operated in a commercial environment. This equipment generates, uses, and can radiate radio frequency energy and, if not installed and used in accordance with the instruction manual, may cause harmful interference to radio communications. Operation of this equipment in a residential area is likely to cause harmful interference in which case the user will be required to correct the interference at his own expense.



Changes or modifications not expressly approved by the party responsible for compliance could void the user's authority to operate the equipment.

Use only an RF shielded cable that was supplied with the display when connecting this display to a computer device.

To prevent damage which may result in fire or shock hazard, do not expose this appliance to rain or excessive moisture.

This device complies with Part 15 of the FCC Rules. Operation is subject to the following two conditions: (1) This device may not cause harmful interference, and (2) this device must accept any interference received, including interference that may cause undesired operation.

## Polish Center for Testing and Certification Notice

The equipment should draw power from a socket with an attached protection circuit (a three-prong socket). All equipment that works together (computer, display, printer, and so on) should have the same power supply source.

The phasing conductor of the room's electrical installation should have a reserve short-circuit protection device in the form of a fuse with a nominal value no larger than 16 amperes (A).

To completely switch off the equipment, the power supply cable must be removed from the power supply socket, which should be located near the equipment and easily accessible.

A protection mark "B" confirms that the equipment is in compliance with the protection usage requirements of standards PN-93/T-42107 and PN-89/E-06251.

### ***Wymagania Polskiego Centrum Badań i Certyfikacji***

Urządzenie powinno być zasilane z gniazda z przyłączonym obwodem ochronnym (gniazdo z kolkiem). Współpracujące ze sobą urządzenia (komputer, monitor, drukarka) powinny być zasilane z tego samego źródła.

Instalacja elektryczna pomieszczenia powinna zawierać w przewodzie fazowym rezerwową ochronę przed zwarciami, w postaci bezpiecznika o wartości znamionowej nie większej niż 16A (amperów).

W celu całkowitego wyłączenia urządzenia z sieci zasilania, należy wyjąć wtyczkę kabla zasilającego z gniazdka, które powinno znajdować się w pobliżu urządzenia i być łatwo dostępne.

Znak bezpieczeństwa "B" potwierdza zgodność urządzenia z wymaganiami bezpieczeństwa użytkownika zawartymi w PN-93/T-42107 i PN-89/E-06251.

### ***Pozostałe instrukcje bezpieczeństwa***

- Nie należy używać wtyczek adapterowych lub usuwać kołka obwodu ochronnego z wtyczki. Jeżeli konieczne jest użycie przedłużacza to należy użyć przedłużacza 3-żyłowego z prawidłowo połączonym przewodem ochronnym.
- System komputerowy należy zabezpieczyć przed nagłymi, chwilowymi wzrostami lub spadkami napięcia, używając eliminatora przepięć, urządzenia dopasowującego lub bezzakłócenowego źródła zasilania.
- Należy upewnić się, aby nic nie leżało na kablach systemu komputerowego, oraz aby kable nie były umieszczone w miejscu, gdzie można byłoby na nie nadeptywać lub potykać się o nie.
- Nie należy rozlewać napojów ani innych płynów na system komputerowy.
- Nie należy wpychać żadnych przedmiotów do otworów systemu komputerowego, gdyż może to spowodować pożar lub porażenie prądem, poprzez zwarcie elementów wewnętrznych.
- System komputerowy powinien znajdować się z dala od grzejników i źródeł ciepła. Ponadto, nie należy blokować otworów wentylacyjnych. Należy unikać kładzenia luźnych papierów pod komputer oraz umieszczania komputera w ciasnym miejscu bez możliwości cyrkulacji powietrza wokół niego.

## Electric, Magnetic and Electromagnetic Fields ("EMF")

1. We manufacture and sell many products targeted at consumers, which, like any electronic apparatus, in general have the ability to emit and receive electromagnetic signals.
2. One of our leading Business Principles is to take all necessary health and safety measures for our products, to comply with all applicable legal requirements and to stay well within the EMF standards applicable at the time of producing the products.
3. We are committed to develop, produce and market products that cause no adverse health effects.
4. We confirm that if its products are handled properly for their intended use, they are safe to use according to scientific evidence available today.
5. We play an active role in the development of international EMF and safety standards, enabling us to anticipate further developments in standardization for early integration in its products.

## North Europe (Nordic Countries) Information

Placering/Ventilation

**VARNING:**

FÖRSÄKRA DIG OM ATT HUVUDBRYTARE OCH UTTAG ÄR LÄTÅTKOMLIGA, NÄR DU STÄLLER DIN UTRUSTNING PÅPLATS.

Placering/Ventilation

**ADVARSEL:**

SØRG VED PLACERINGEN FOR, AT NETLEDNINGENS STIK OG STIKKONTAKT ER NEMT TILGÆNGELIGE.

Paikka/Ilmankierto

**VAROITUS:**

SJJOITA LAITE SITEN, ETTÄ VERKKOJOHTO VOIDAAN TARVITTAESSA HELPOSTI IRROTTAA PISTORASIESTA.

Placering/Ventilasjon

**ADVARSEL:**

NÅR DETTE UTSTYRET PLASSERES, MÅ DU PASSE PÅ AT KONTAKTENE FOR STØMTILFØRSEL ER LETTE Å NÅ.

## China RoHS

电子电气产品有害物质限制使用标识要求 (中国RoHS法规标识要求) 产品中有害物质的名称及含量。

零部件名称	有害物质					
	铅 (Pb)	汞 (Hg)	镉 (Cd)	六价铬 (Cr (VI))	多溴联苯 (PBB)	多溴二苯醚 (PBDE)
塑料外框	○	○	○	○	○	○
后壳	○	○	○	○	○	○
电路板组件*	×	○	○	○	○	○
其他线材	×	○	○	○	○	○

\*: 电路板组件包括印刷电路板及其构成的零部件，如电阻、电容、集成电路、连接器等。

本表格依据SJ/T 11364的规定编制。

○: 表示该有害物质在该部件所有均质材料中的含量均在 GB/T 26572 标准规定的限量要求以下。

×: 表示该有害物质至少在该部件的某一均质材料中的含量超出 GB/T 26572 标准规定的限量要求。

上表中打“×”的部件中，应功能需要，部分有害物质含量超出GB/T 26572规定的限量要求，但是符合欧盟RoHS法规要求(属于豁免部分)。

备注: 上表仅做为范例，实际标示时应依照各产品的实际部件及所含有害物质进行标示。



## 环保使用期限

此标识指期限(十年)，电子电气产品中含有的有害物质在正常使用的条件下不会发生外泄或突变，电子电气产品用户使用该电子电气产品不会对环境造成严重污染或对其人身、财产造成严重损害的期限。

### 《废弃电器电子产品回收处理管理条例》提示性说明

为了更好地关爱及保护地球，当用户不再需要此产品或产品寿命终止时，请遵守国家废弃电器电子产品回收处理相关法律法规，将其交给当地具有国家认可的回收处理资质的厂商进行回收处理。

#### 警告

此为A级产品。在生活环境中，该产品可能会造成无线电干扰。在这种情况下，可能需要用户对干扰采取切实可行的措施。

單元	限用物質及其化學符號					
	鉛 (Pb)	汞 (Hg)	鎘 (Cd)	六價鉻 (Cr <sup>+6</sup> )	多溴聯苯 (PBB)	多溴二苯醚 (PBDE)
塑料外框	○	○	○	○	○	○
後殼	○	○	○	○	○	○
電路板組件	—	○	○	○	○	○
其他線材	—	○	○	○	○	○

備考1. “○” 係指該項限用物質之百分比含量未超出百分比含量基準值。  
備考2. “—” 係指該項限用物質為排除項目。

警語：使用過度恐傷害視力。

注意事項：

- (1) 使用30分鐘請休息10分鐘。
- (2) 未滿2歲幼兒不看螢幕，2歲以上每天看螢幕不要超過1小時。

警告使用者：

此為甲類資訊技術設備，於居住環境中使用時，可能會造成射頻擾動，在此種情況下，使用者會被要求採取某些適當的對策。

## Turkey RoHS:

Türkiye Cumhuriyeti: EEE Yönetmeliğine Uygundur

## Ukraine RoHS:

Обладнання відповідає вимогам Технічного регламенту щодо обмеження використання деяких небезпечних речовин в електричному та електронному обладнанні, затвердженого постановою Кабінету Міністрів України від 3 грудня 2008 № 1057

## End-of-Life Disposal

Your new Public Information Display contains materials that can be recycled and reused. Specialized companies can recycle your product to increase the amount of reusable materials and to minimize the amount to be disposed of.

Please find out about the local regulations on how to dispose of your old OPS Module from your local Philips dealer.

### (For customers in Canada and U.S.A.)

This product may contain lead and/or mercury. Dispose of in accordance to local-state and federal regulations. For additional information on recycling contact [www.eia.org](http://www.eia.org) (Consumer Education Initiative)

## Waste Electrical and Electronic Equipment-WEEE

### Attention users in European Union private households



This marking on the product or on its packaging illustrates that, under European Directive 2012/19/EU governing used electrical and electronic appliances, this product may not be disposed of with normal household waste. You are responsible for disposal of this equipment through a designated waste electrical and electronic equipment collection. To determine the locations for dropping off such waste electrical and electronic, contact your local government office, the waste disposal organization that serves your household or the store at which you purchased the product.

### Attention users in United States:

Please dispose of according to all Local, State and Federal Laws. For the disposal or recycling information, contact: [www.mygreenelectronics.com](http://www.mygreenelectronics.com) or [www.eiae.org](http://www.eiae.org).

### End of Life Directives-Recycling



Your new Public Information Display contains several materials that can be recycled for new users.

Please dispose of according to all Local, State, and Federal laws

### Restriction on Hazardous Substances statement (India)

This product complies with the "E-Waste (Management) Rules, 2016" CHAPTER V, rule 16, sub-rule (1) .Whereas New Electrical and Electronic Equipment and their components or consumables or parts or spares do not contain Lead, Mercury, Cadmium, Hexavalent Chromium, polybrominated biphenyls and polybrominated diphenyl ethers beyond a maximum concentration value of 0.1% by weight in homogenous materials for lead, mercury, hexavalent chromium, polybrominated biphenyls and polybrominated diphenyl ethers and of 0.01% by weight in homogenous materials for cadmium, except of exemptions set in Schedule 2 of the Rule.

### E-Waste Declaration for India



This symbol on the product or on its packaging indicates that this product must not be disposed of with your other household waste. Instead it is your responsibility to dispose of your waste equipment by handing it over to a designated collection point for the recycling of waste electrical and electronic equipment .The separate collection and recycling of your waste equipment at the time of disposal will help to conserve natural resources and ensure that it is recycled in a manner that protects human health and the environment. For more information about E -waste please visit <http://www.india.philips.com/about/sustainability/recycling/index.page> and to know where you can drop off your waste equipment for recycling in India please contact on below given contact details.

Helpline number: 1800-425-6396 (Monday to Saturday, 9 a.m. to 5:30 pm)

Centralized E-waste collection center

Address: TPV Technology India Private Limited,

59, Maheswari Nagar, 1st Main Road, Mahadevapura Post, Whitefield Road

Bangalore, Karnataka, PIN: 560048, Tel: 080-3023-1000

E-mail: [india.callcentre@tpv-tech.com](mailto:india.callcentre@tpv-tech.com)

Information for EAC	
Month and year of manufacturing	please refer information in Rating label.
Name and location of manufacturer	ООО “Профтехника” Адрес: 3-й Проезд Марьиной роши, 40/1 офис 1. Москва, 127018, Россия
Importer and information	Наименование организации: ООО “Профтехника” Адрес: 3-й Проезд Марьиной роши, 40/1 офис 1. Москва, 127018, Россия Контактное лицо: Наталья Астафьева, +7 495 640 20 20 <a href="mailto:nat@profdisplays.ru">nat@profdisplays.ru</a>



# Table Of Contents

<b>1. Unpacking and Installation</b> .....	<b>1</b>
1.1. Unpacking.....	1
1.2. Package Contents.....	1
1.3. Installation Notes.....	1
1.4. Installing in Display .....	2
1.5. Input/Output Terminals.....	3
<b>2. Operation</b> .....	<b>4</b>
2.1. Watch the Connected Video Source.....	4
2.2. Change Picture Format.....	4
2.3. Overview.....	4
<b>3. Signage display</b> .....	<b>6</b>
3.1. Setting.....	6
3.2. Wi-Fi (Show up when plug in Wi-Fi dongle).....	6
3.3. Ethernet.....	6
3.4. Signage Display.....	7
3.5. Display .....	15
3.6. Storage.....	15
3.7. Security.....	16
3.8. Languages & input.....	16
3.9. Date & time .....	17
3.10. Developer options.....	17
3.11. About .....	17
3.12. Legal Information.....	18
3.13. Supplementary .....	18
<b>4. USB device compatibility</b> .....	<b>21</b>
<b>5. Cleaning</b> .....	<b>23</b>
<b>6. Technical Specifications</b> .....	<b>24</b>

# 1. Unpacking and Installation

## 1.1. Unpacking

- This product is packed in a carton, together with the standard accessories.
- Any other optional accessories will be packed separately.
- After opening the carton, ensure that the contents are complete and in good condition.

## 1.2. Package Contents

Please verify that you received the following items with your package content:

- CRD50
- Quick start guide
- Antenna cable x2
- M2 screw x3

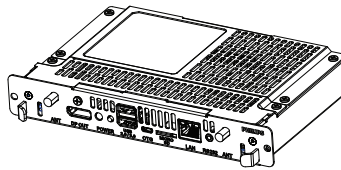

CRD50



Quick start guide



Antenna cable x 2



M2

\* Differences according to regions

Display design and accessories may differ from those illustrated above.

### NOTES:

- For all other regions, apply a power cord that conforms to the AC voltage of the power socket and has been approved by and complies with the safety regulations of the particular country (Type H05W-F, 2G or 3G, 0.75 or 1 mm<sup>2</sup> should be used).
- You might like to save the package OPS Module and packing material for shipping the OPS Module.

## 1.3. Installation Notes

- Due to the high power consumption, always use the plug exclusively designed for this product. If an extended line is required, please consult your service agent.
- Avoid installing the product in the kitchen, bathroom or any other places with high humidity so as not to shorten the service life of the electronic components.
- The product can normally operate only under 3000m in altitude. In installations at altitudes above 3000m, some abnormalities may be experienced.

## 1.4. Installing in Display

### To install CRD50:

1. Ensure your display is powered off.
2. Remove the screws of OPS cover from the display .
3. After inserting the CRD50 in the display, tighten the screws.

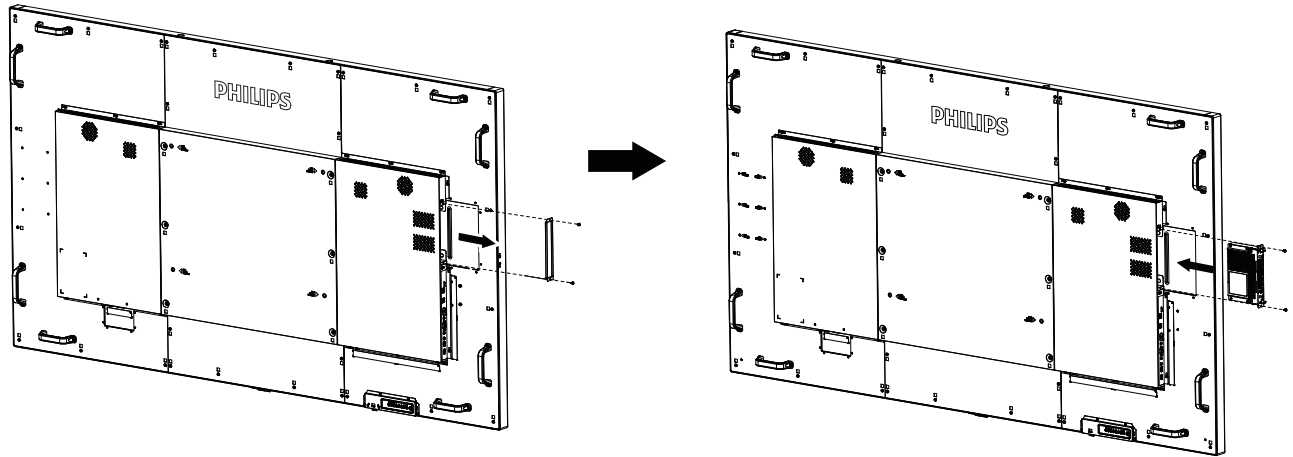

## 1.5. Input/Output Terminals

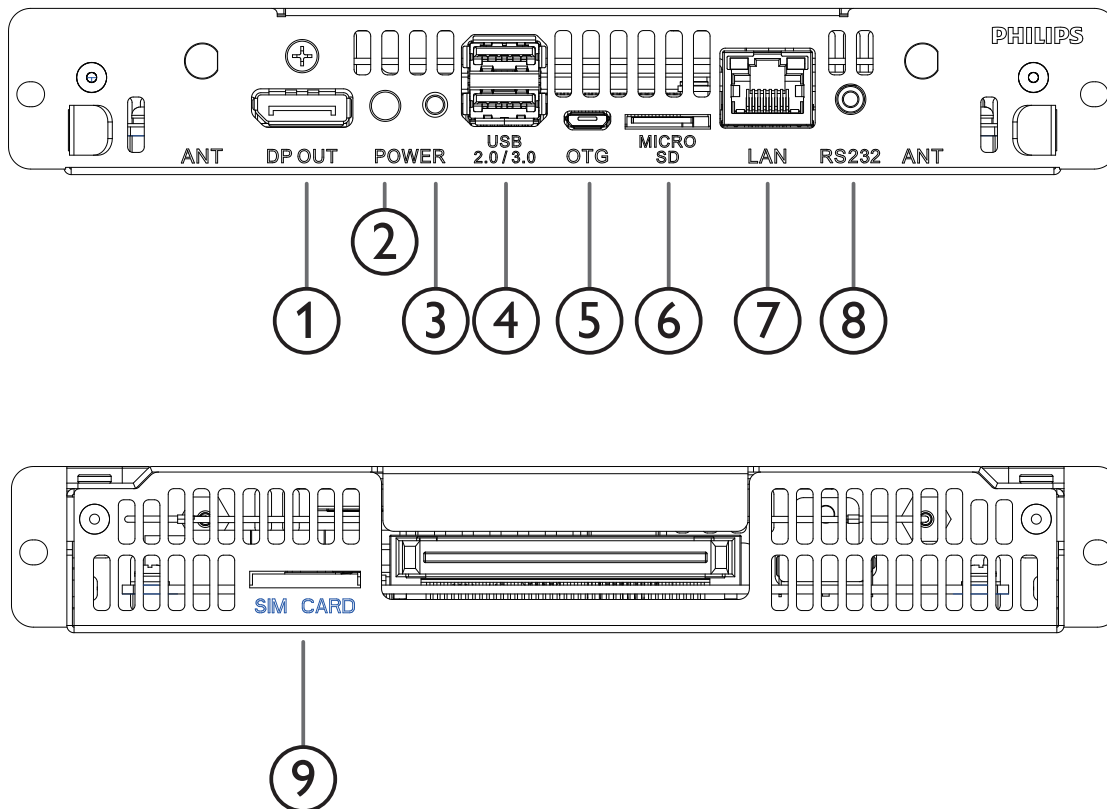

① **DisplayPort OUT**

DisplayPort video output.

② **Power Indicator**

Show the power indicator.

③ **Power Button**

Press this button to turn the CRD50 on/off.

④ **USB 2.0 / 3.0 PORT**

Insert your USB storage device

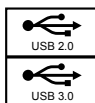

⑤ **OTG**

For service (update FW or debug).

⑥ **MICRO SD CARD**

Insert your MICRO SD CARD.

⑦ **LAN**

LAN control function for the use of remote control signal from control center.

⑧ **RS232C**

RS232C network input / output for the loop-through function.

⑨ **SIM CARD**

Insert your SIM CARD.

## 2. Operation

**NOTE:** The control button described in this section is mainly on the remote control unless specified otherwise.

### 2.1. Watch the Connected Video Source

1. Press **[→]** SOURCE button.
2. Press **[A]** or **[T]** button to choose a device, then press **[OK]** button.

### 2.2. Change Picture Format

You can change the picture format to suit the video source. Each video source has its available picture formats.

The available picture formats depend on the video source:

1. Press **[F]** FORMAT button.
2. Press **[A]** or **[T]** button to choose a picture format, then press **[OK]** button.
  - PC mode: {Full} / {4:3} / {1:1} / {16:9} / {21:9} / {Custom}.
  - Video mode: {Full} / {4:3} / {1:1} / {16:9} / {21:9} / {Custom}.

### 2.3. Overview

1. Android launcher:
  - Android launcher as below:  
(Source is one of Browser, Media Player, PDF Player, SmartCMS and Custom APKs)  
When booting animation finished, launcher can appear. If a source was selected, then it will launch the selected source immediately. If no source selected, then it goes to the following page.

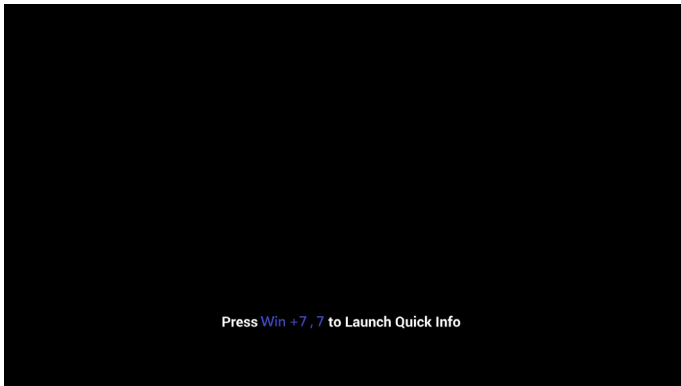

- For a few seconds, it will be a black screen.

Note : any time, system will show the following picture if no HID input device (USB keyboard or mouse), can be detected by system.

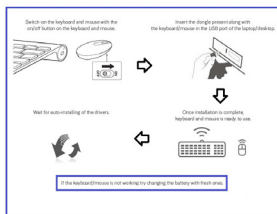

2. Admin mode:
  - You can press "WIN, 1,8,8,8" to startup admin mode. (Or by up/down dragging, vertical distance > screen height/4 to startup admin PIN query for touch host PD.) You have to input password before Admin mode.

Note : Default password is 0000

Input correct password for validation, then you can **Select Settings >> Signage Display >> System tools >> Password** to change password.

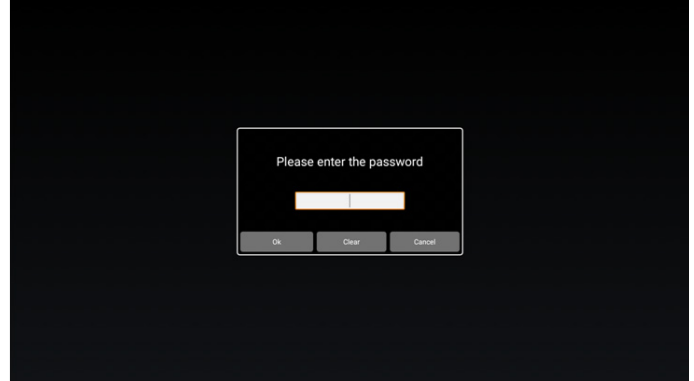

- Admin mode will show five icons: "Settings", "Apps", "Network", "Storage" and "Help".
- When you leave admin mode, system will return to Launcher:

1) Home page of admin mode, this page has five items: "Settings", "Apps", "Network", "Storage" and "Help".

Settings : go to settings app.

Applications : show all apps.

Network : set Wi-fi, Ethernet and Mobile network (optional).

Storage : go to storage page

Help : display QRcode.

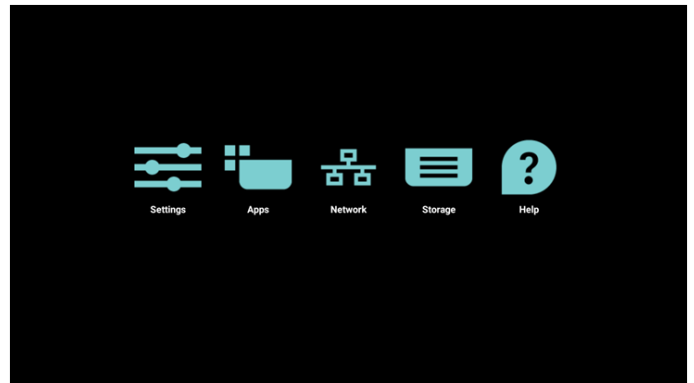

2.) Settings page:

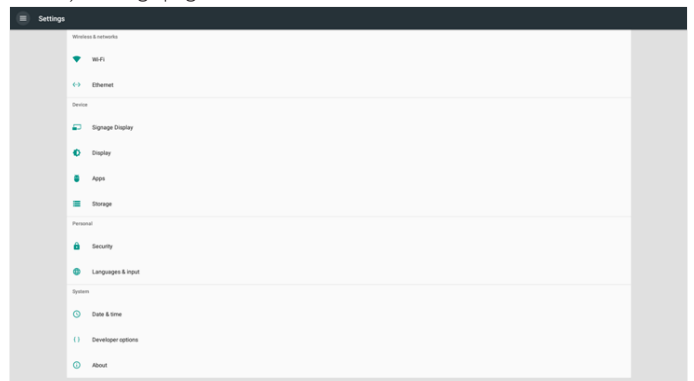

3.) Application page:

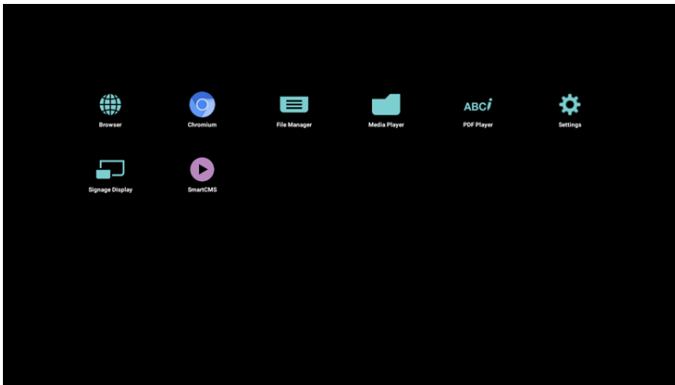

4.) Network page

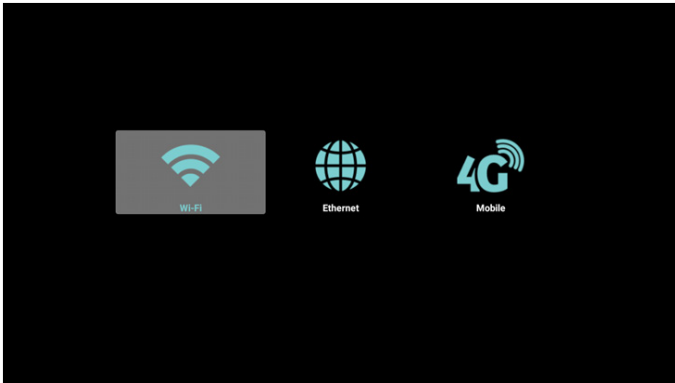

4.1) Wi-Fi page

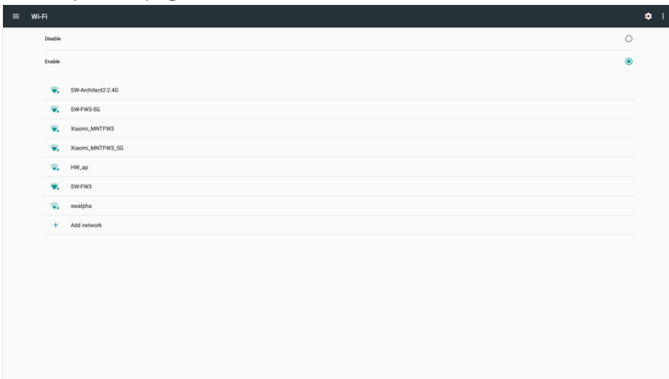

4.2) Ethernet page

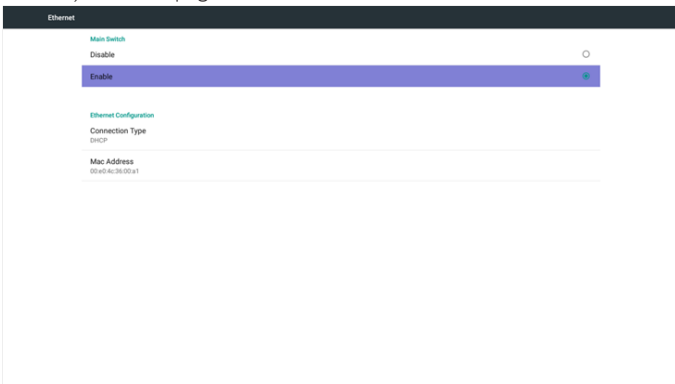

4.3) Cellular Network (Optional, if device has GSM/LTE module)

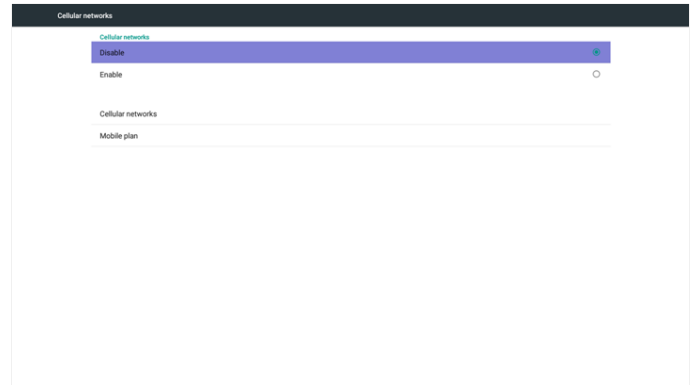

5) Help page:

Display QRcode page.



### 3. Signage display

#### 3.1. Setting

Main items:

- (1) Wi-Fi (Show up when plug in Wi-Fi dongle)
- (2) Ethernet
- (3) Signage Display
- (4) Display
- (5) Apps
- (6) Storage
- (7) Security
- (8) Language & input
- (9) Date & time
- (10) Developer options
- (11) About

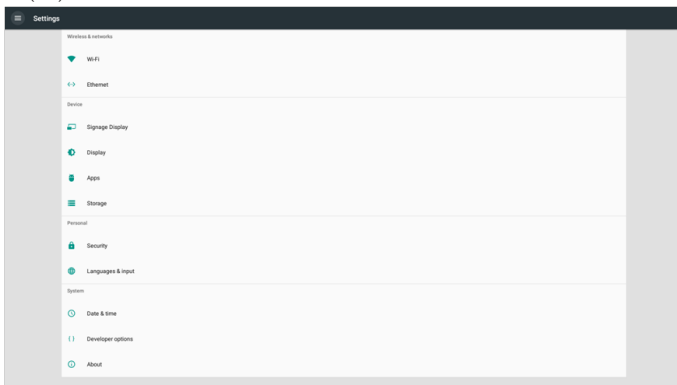

#### 3.2. Wi-Fi (Show up when plug in Wi-Fi dongle)

Via Enable/Disable to control Wi-Fi On/OFF. After Enable, the screen will list all available Wi-Fi AP.

Note :

1. Ethernet will be disable automatically if Wi-Fi turn on and connect to network.
2. A particular model of Wi-Fi module is required. Please consult the dealer or service technician for help.

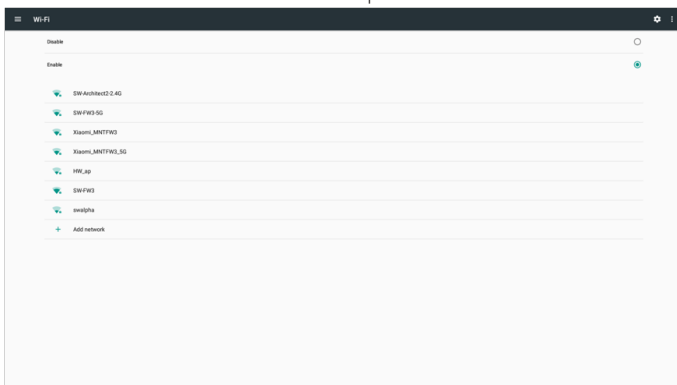

#### 3.3. Ethernet

Enable/Disable to turn on/off Ethernet

After enable Ethernet, the settings will show:

- (1) Connection Type (Available connection type: DHCP/Static IP)
  - A. DHCP
  - B. Static IP
  - C. IP Address
  - D. Netmask
  - E. DNS Address
  - F. Gateway
- (2) Mac Address

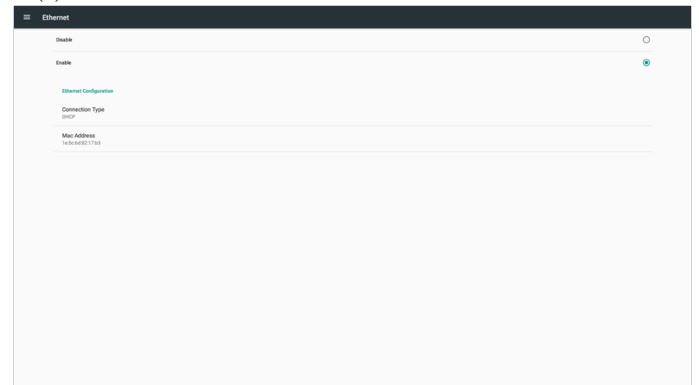

Note:

Ethernet will be disabled automatically when Wi-Fi on and connect to network.

##### 3.3.1. DHCP

DHCP mode:

- (1) Cannot modify IP Address, Netmask, DNS Address and Gateway.
- (2) If connect successfully, it will display current network configuration.

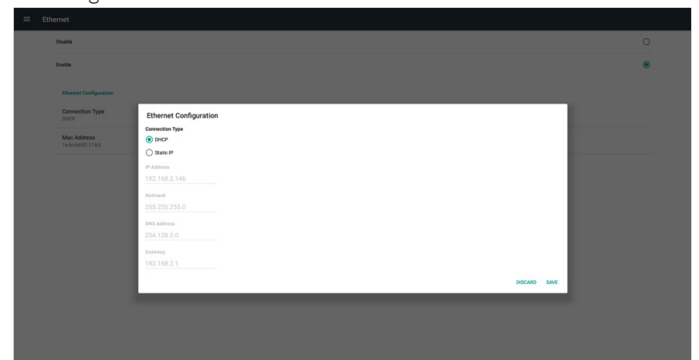

### 3.3.2. Static IP

In Static IP mode, user can input IP Address, Netmask, DNS address and Gateway

Note:

IP address, netmask, DNS address and gateway address input limitation

- (1)Format:
  - I. number 0-9
  - II. decimal point “.”

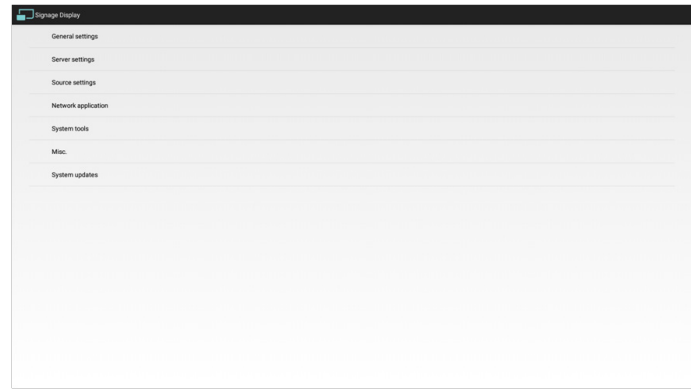
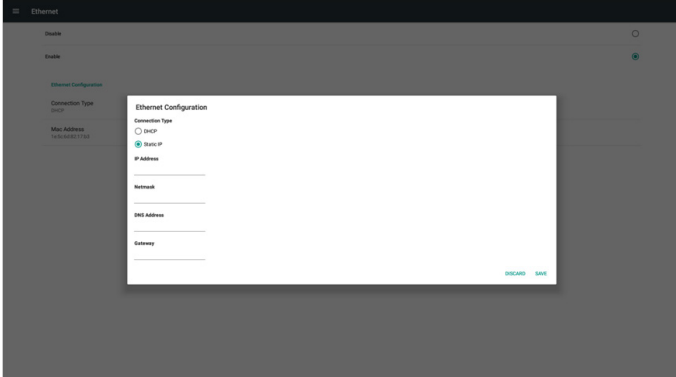

### 3.4.1. General Settings

1. Signage Display Name

Set up PD name “PD\_” + Ethernet Mac Address.

Note:

Input limitation:

- (1) length: Max 36 characters
- (2) format: no limit

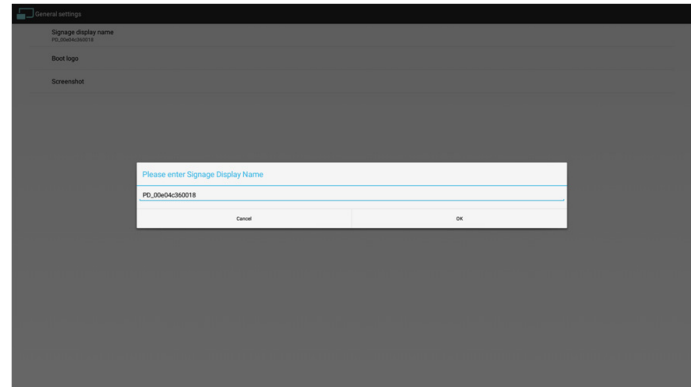

### Boot Logo

To change Android boot logo, user can change to their own boot logo animation file.

Note:

- (1) Boot animation file name: bootanimzation.zip
- (2) Will pop-up a window for user to select USB and SD card. No priority issue.

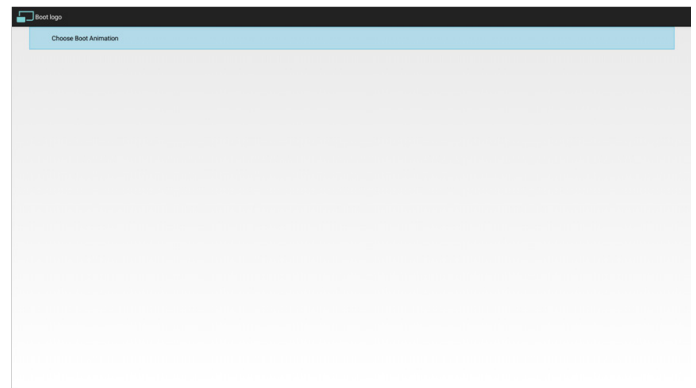

## 3.4. Signage Display

Divide into 4 groups: General Settings / Server Settings / Source Settings / Security

- (1) General Settings
  - A. Signage Display Name
  - B. Boot Logo
  - C. Screenshot
- (2) Server Settings
  - A. Email Notification
  - B. FTP
- (3) Source Settings
  - A. Media Player
  - B. Browser
  - C. CMND & Play
  - D. PDF Player
  - E. Custom App
  - F. Boot on Source
- (4) Network application
  - A. Proxy
  - B. Platform Web API
  - C. SICP Network Port
- (5) System tools
  - A. Clear Storage
  - B. Reset
  - C. Import & Export
  - D. Clone
  - E. Security
- (6) Misc.
  - A. TeamViewer Support
- (7) System updates
  - A. Local Update



2) When boot logo is selected, PD will check if there is bootanimzation.zip in the USB and SD card.

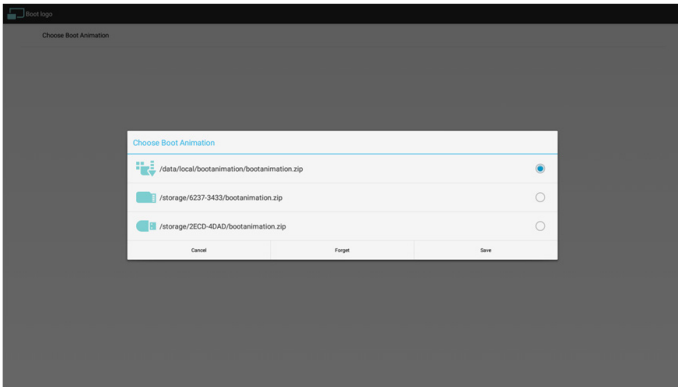

Function introduction:

a. Option description



Use customized boot animation file which is copied from SD card or USB





Use boot animations file under SD card



Use boot animations file under USB

b. Save

If the option focus on  or , press Save key to save the bootanimzation.zip file from the SD card or USB to /data/local and set it as boot logo.

c. Forget

Press Forget key to delete /data/local/bootanimzation.zip and not show boot logo.

d. Cancel

Close the dialogue without any changes.

Scenario introduction:

Case 1

The user don't select customized boot logo. PD does not find any bootanimzation.zip file under SD and USB. The list will be blank. Save and Forget button will be grayed out.

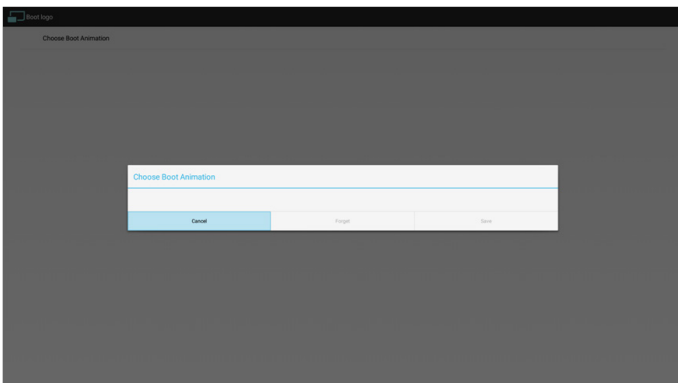

Case 2

The user put customized bootanimzation.zip file in the SD and USB. The default priority is SD card, so the PD will automatically select the file in the SD card only. The file in the USB drive will be ignored. In case the bootanimzation.zip is only in the USB drive, then the PD will select the file in the USB drive (as the SD card has no file).

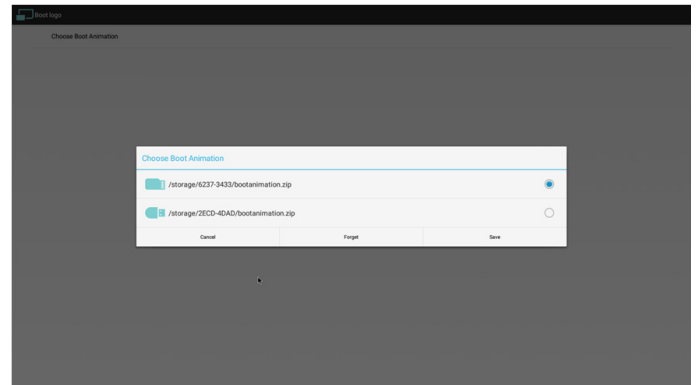

Case 3

The user selects customized boot logo, the screen will show /data/local/bootanimzation.zip.

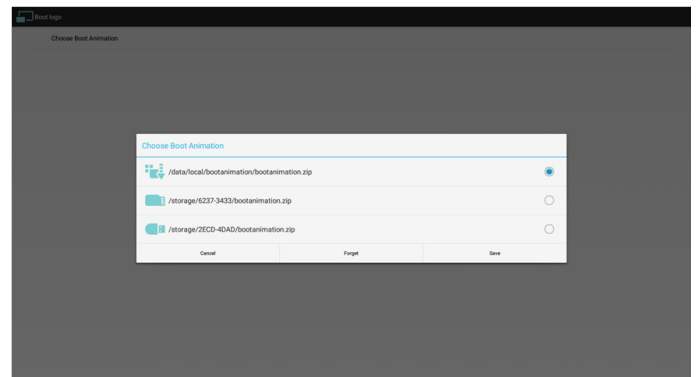

3) If OSD menu Logo item is On or Off, the users cannot choose boot animation in Android settings.

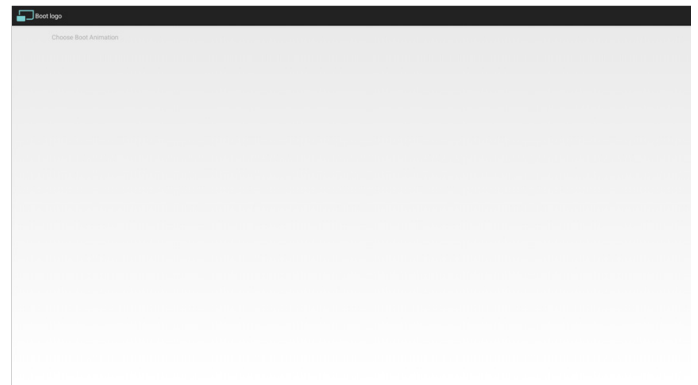

2. Screenshot

Via Enable/Disable to control screenshot On/Off. After Enable, user can set screenshot timeslot and save path.

Note:

Time slot of deletion and screenshot:

- (1) Will delete picture at initial time 0 sec.
- (2) Will screenshot at first 40 sec.

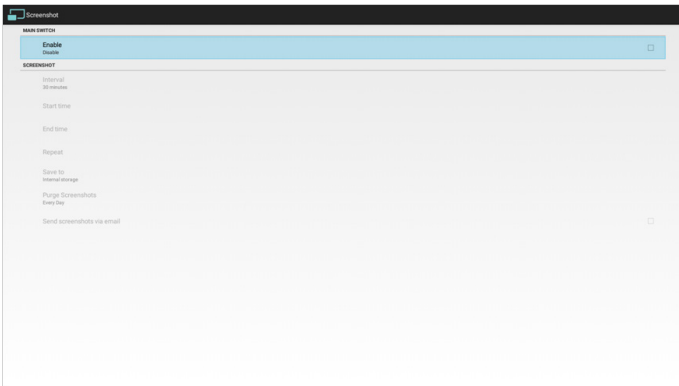

### 1) Interval

Set up interval timeframe. 30 mins or 60 mins.

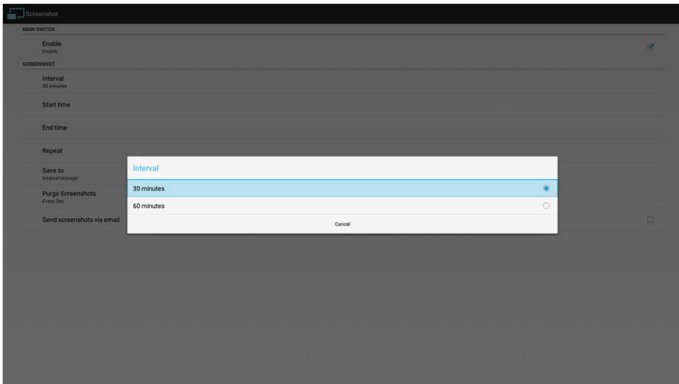

### 2) Start Time

Set up screenshot start time.

Note:

- (1) If no start time, the screen will show current time automatically
- (2) Just press Back key to exit dialog for Set up
- (3) Start time cannot be newer than End time. It will show Error toast.

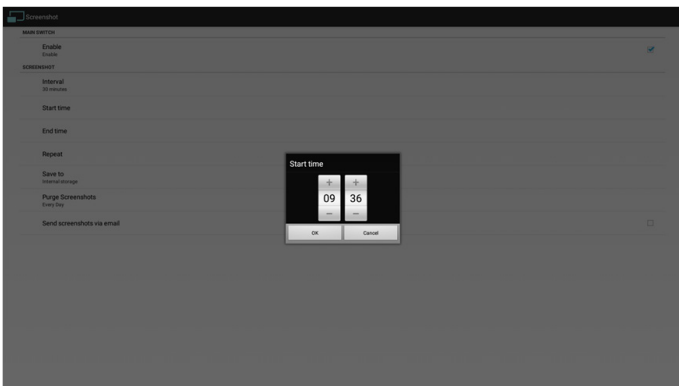

### 3) End Time

Set up screenshot End time



Note :

- (1) If no End time, the screen will show current time automatically
- (2) Start time cannot be newer than End time. It will show error toast.

### 4) Repeat

Set screenshot repeat cycle. User can choose screenshot time frame. (Multiple selection)

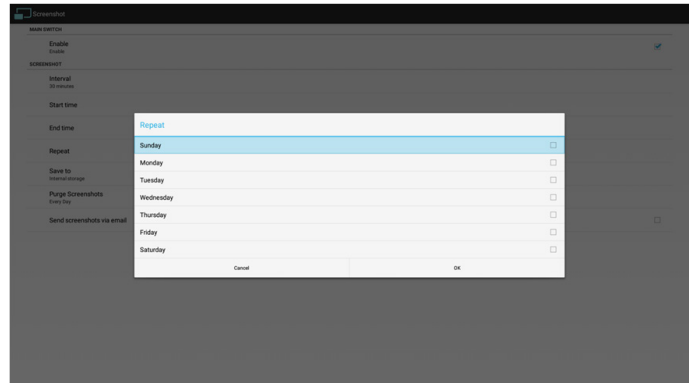

### 5) Save to

Set up screenshot save path. Internal storage, SD card or USB storage.)

Note:

Picture storage path

- (1) In root of internal storage/usb storage/sd card, PD will create folder automatically.
- (2) The picture will save to philips/Screenshot/.

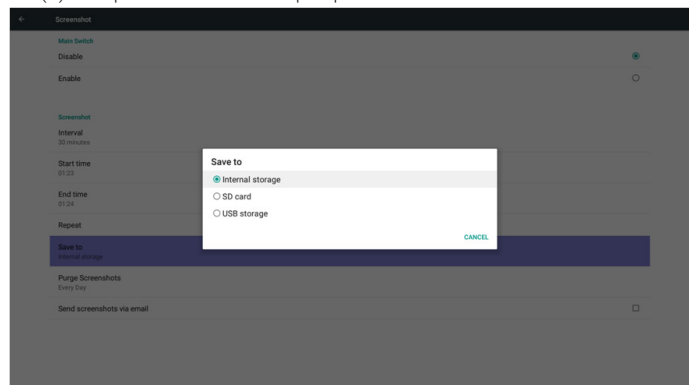

## 6)Purge Screenshots

Set up purge timeframe. One day or One week.

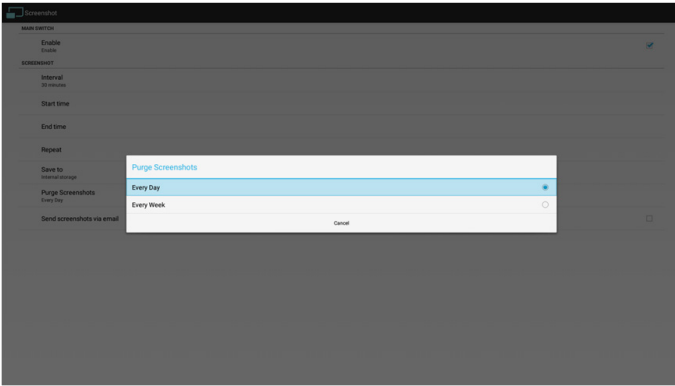

## (7) Send screenshots via email

After check this item, it will send screenshot to email of administrator  
Please refer to Email notification

Note:

- Please confirm Email setting is done.
- Each screenshot will be sent immediately.

## 3.4.2. Server Settings

### 1. Email Notification

Via Enable/Disable to control Email On/Off.

After Enable, user can set up Email notification configuration.

The following events are automatically sent mail to manager:

- (1) Critical : Some android system warning message
- (2) Mediaplayer: Playlist is empty, or media file not support. . .
- (3) Browser: Playlist is empty..
- (4) CMND & Play: No content
- (5) Pdfplayer: Playlist is empty
- (6) Ftp: someone login to system

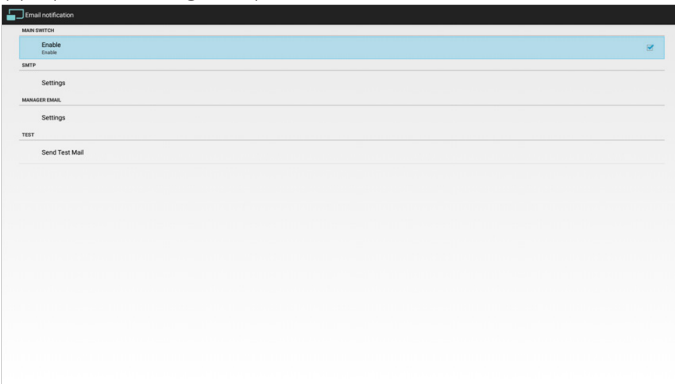

### 1) SMTP

Set SMTP configuration)

User can set Gmail account or other mail account.

User can select other mail account and set up SMTP server; Security type and port item

Note

Password input limitation

- (1) Length: 6-20 characters
- (2) Format: no limit
- (3) unavailable port: 5000

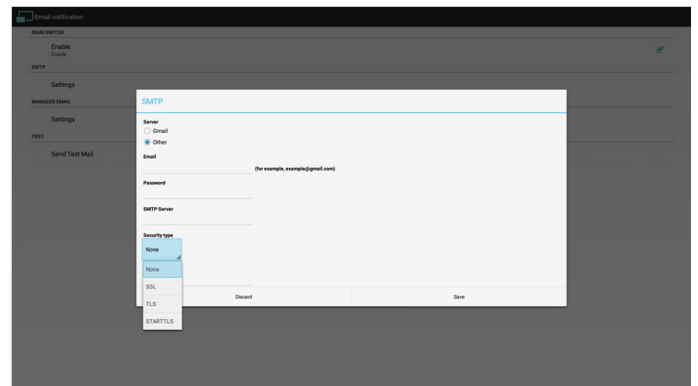
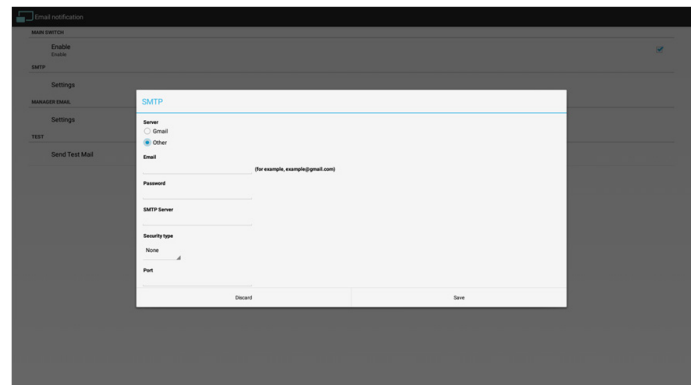
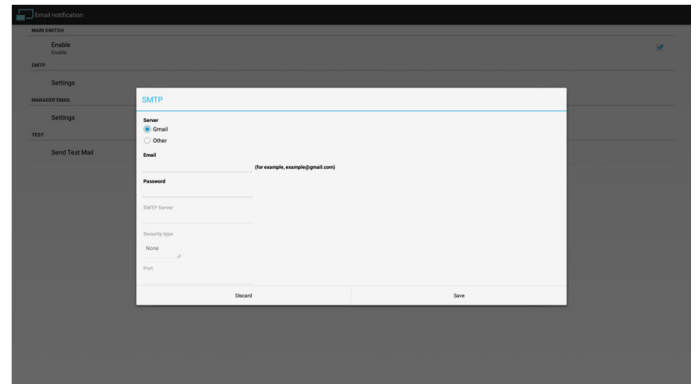

### Gmail safety setting

If Gmail is not working when setting is complete, please test Gmail account via PC and link below URL

<https://www.google.com/settings/security/lesssecureapps>

And confirm "Access for less secure apps" item is Turn On.

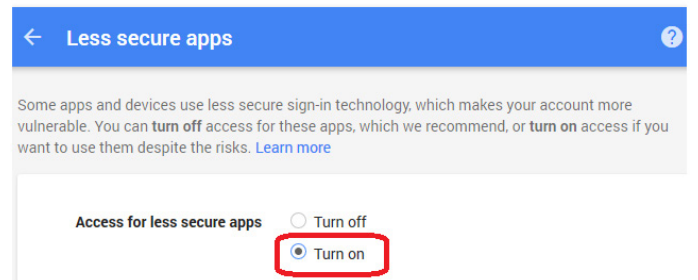

## Yahoo Email Security Setting

If Yahoo Email is not working when setting complete, please confirm "Allow apps that use less secure sign in" item is enabled.

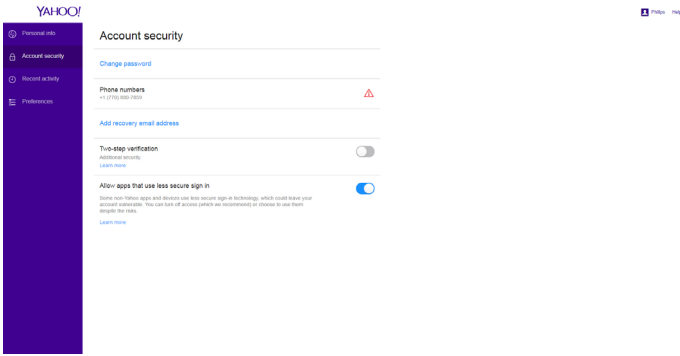

## 2) Manager Email

Set up Receiver mail account

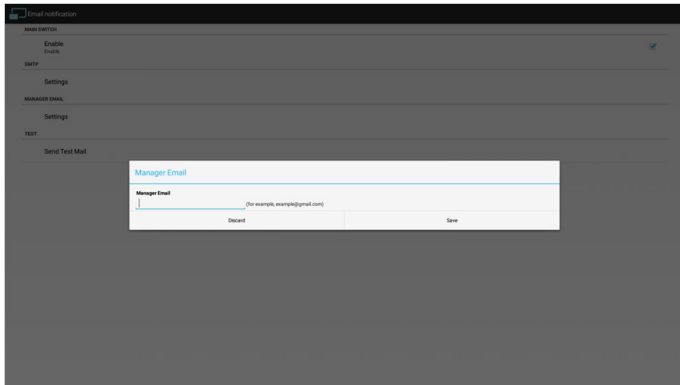

## 3) Test

Send Test Mail

To test Gmail account receive/send function.

Note

(1) When Email is Disable, "Send Test Mail Button" button will gray out

## 2. FTP

Via Enable/Disable to control FTP On/Off. After set up, PD can share FTP files.

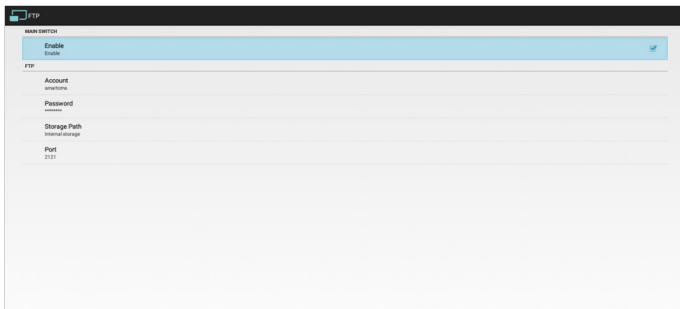

## 1) Account

Set up FTP account

Note:

Input limitation

(1) Length: 4-20 characters

(2) Format:

- I. English a-z and A-Z
- II. Number 0-9

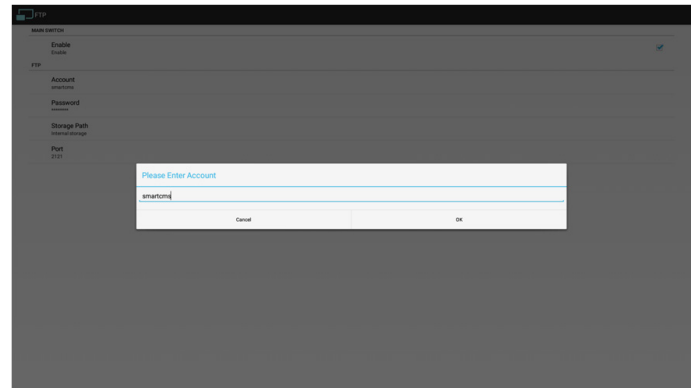

## 2) Password

Set up FTP password.

Note:

Input limitation

(1) Length: 6-20 characters

(2) Format:

- I. English a-z and A-Z
- II. Number 0-9

FTP password display

(1) Will show "\*" symbol to instead password if set up password via remote control.

(2) After set up, the password text will show as "\*" symbol.

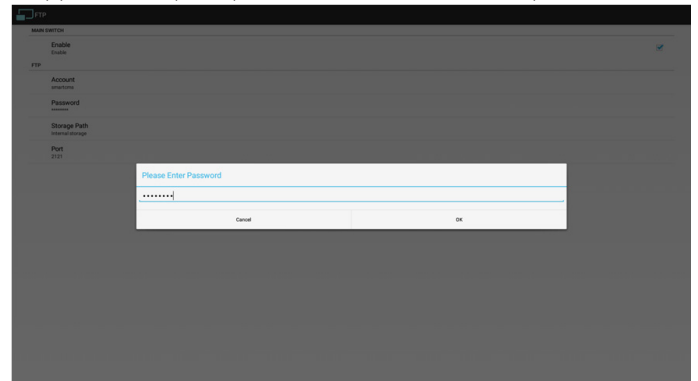

## 3) Storage Path

Show default path: Internal storage

Note:

Can only display Internal storage, cannot be modified.(Only show path)

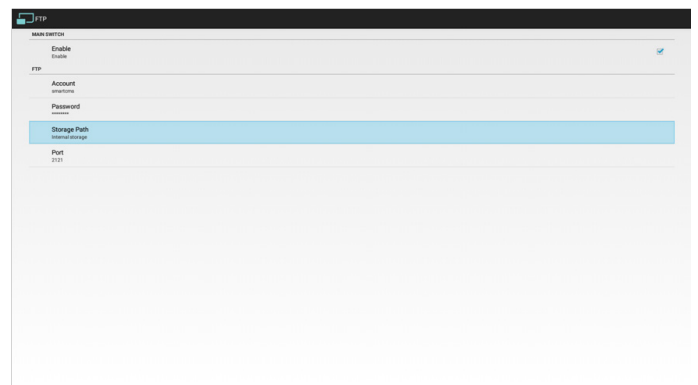

4) Port

Set up FTP port number. Default: 2121

Note:

Input limitation

- (1) Length: Max 5 characters
- (2) Range: 1024 ~ 65535
- (3) Format: Number 0-9
- (4) Unavailable port: 5000
- (5) The port number must more than 1024

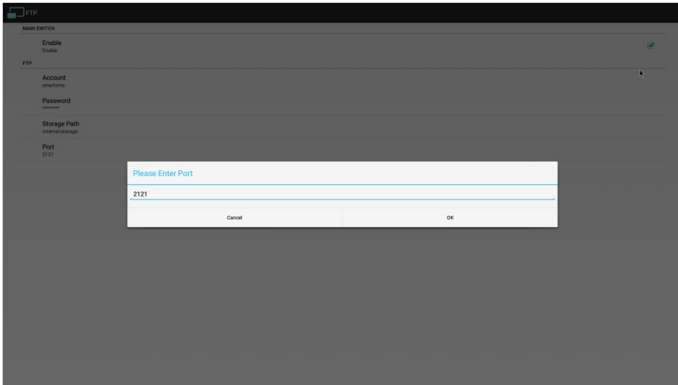

(2) Open Media Player slideshow effect edit page.

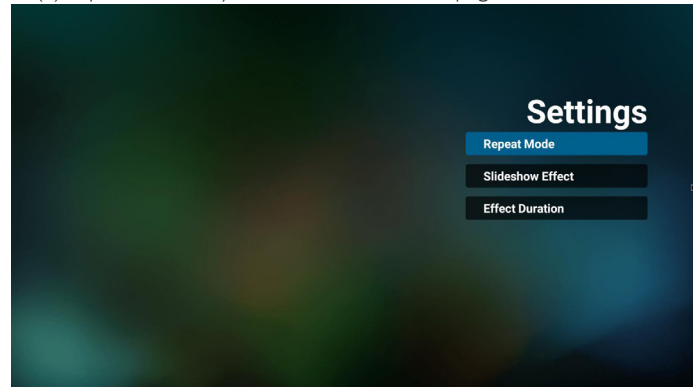

2. Browser

Can edit Bookmark configuration.

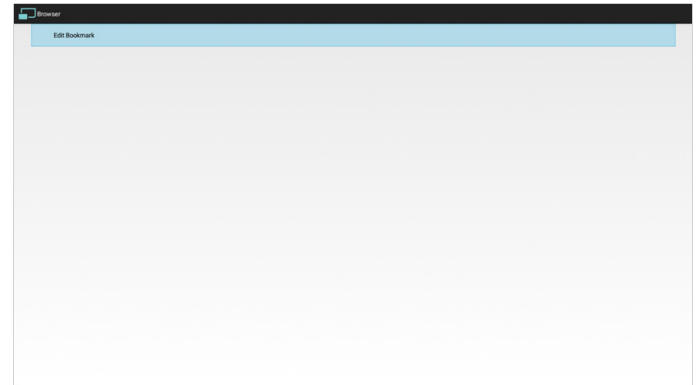

(1) Open Browser setting page.

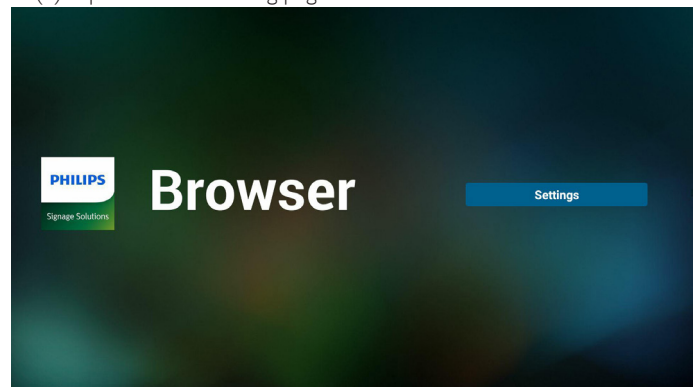

3. CMND & Play

1) Server

Setup CMND & Play server address

2) Account

Setup CMND & Play account

3) PIN Code

Setup CMND & Play PIN code

(4) Version

There are two options, Ver:2 and Ver:3

Ver: 2

Use 2.0/2.2 agreement

Ver: 3

Use 3.0/3.1 agreement

(5) Content

There are 3 options for selection: (1) Internal storage (2) SD card storage (3) USB storage

### 3.4.3. Source Settings

1. Media Player

Can Edit Media Player play list and effect settings.

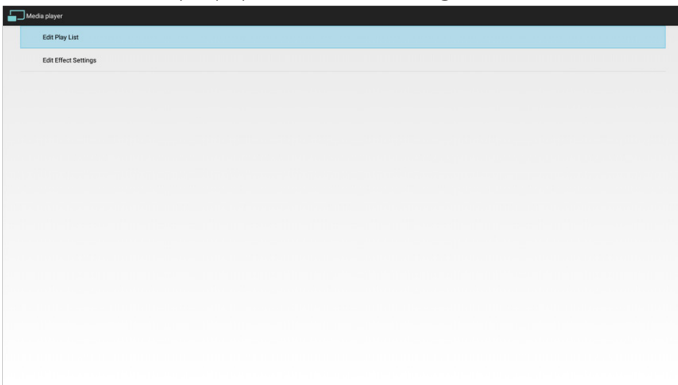

(1) Open Media Player Player List edit page.

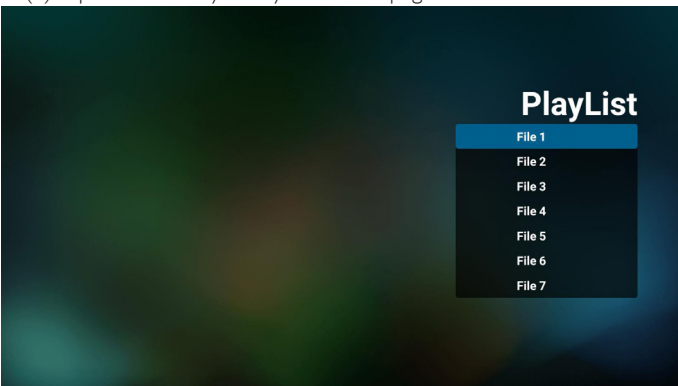

When Ver:2, Server/Account/PIN code will be gray and unavailable.

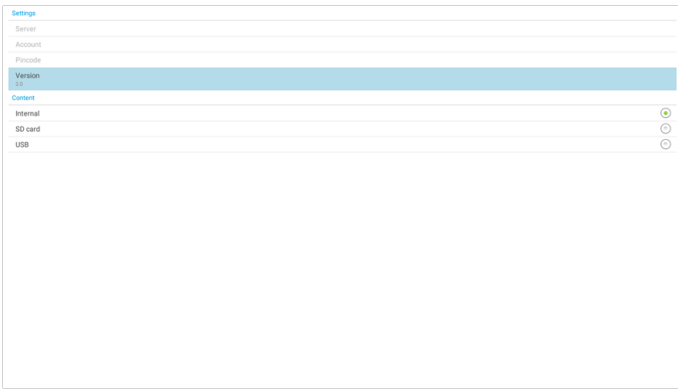

(2) Open PDF Player effect edit page.

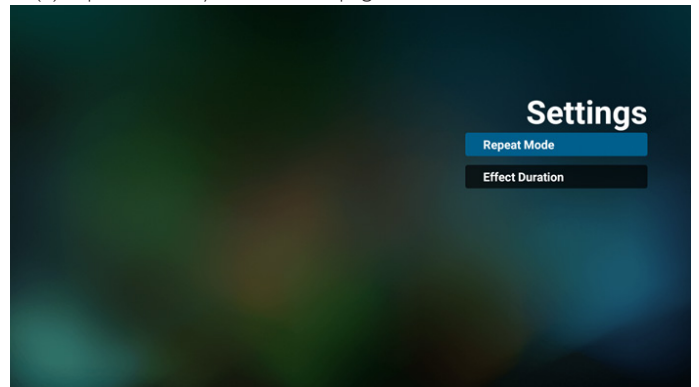

When Ver:3, Server/Account/PIN code is available.

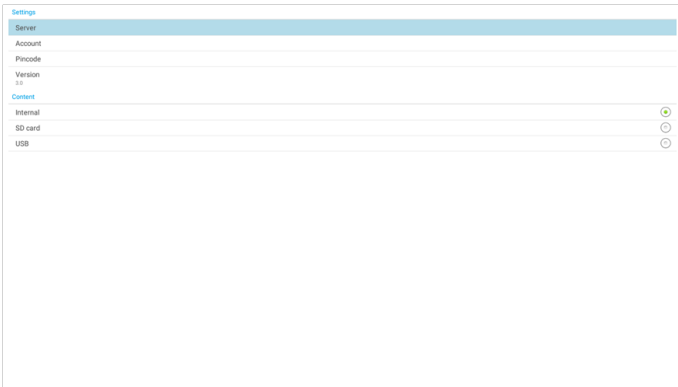

#### 5. Custom App

User can set up the application for Customer Source.

Note

Display pre-installed app. and user installed app.

OSD menu operation:

RCU: Source -> Custom

If set up customer APK, PD will open customer app when switch source to Customer mode.

If no set up customer APK, PD will open default app Signage Display, when switch source to Customer mode.

#### 4. PDF Player

Can edit PDF Player Play List and Effect Settings.

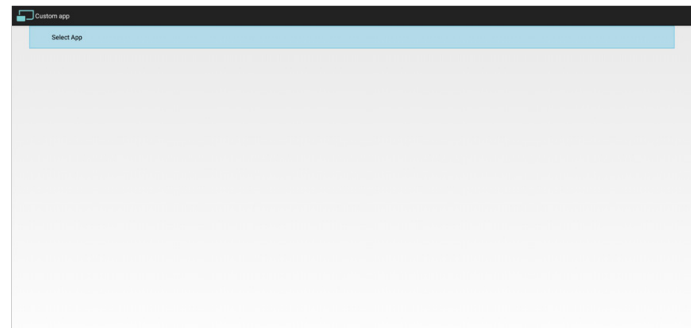
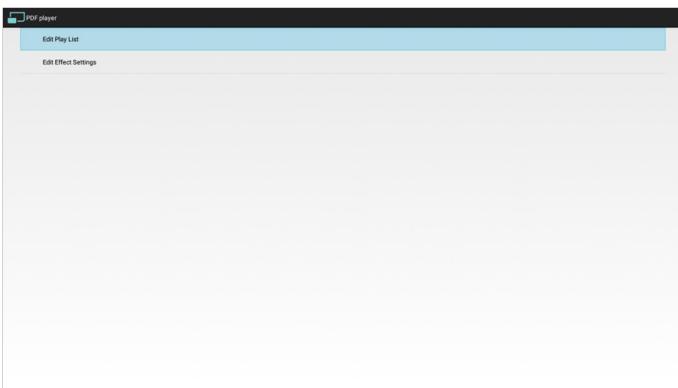

Function introduction

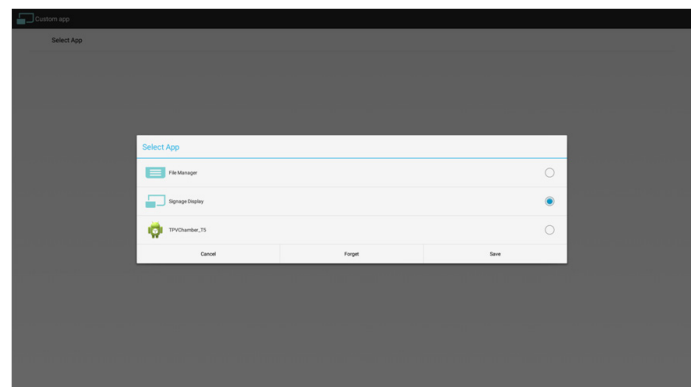

(1) Open PDF Player Player List edit page.

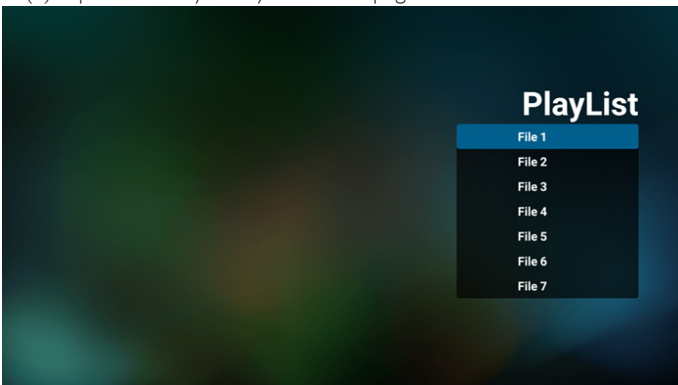

(1) Save

Select App and press Save key to save it.

(2) Forget

Press Forget key to clean previous stored data

(3) Cancel

No change, close window directly

If no customer installed apk, the list will be blank.

No option for choose. Save and Forget key will be gray and unavailable.

## 6. Boot on Source

User can set up the application for Android boot on Source.

Select Video Source

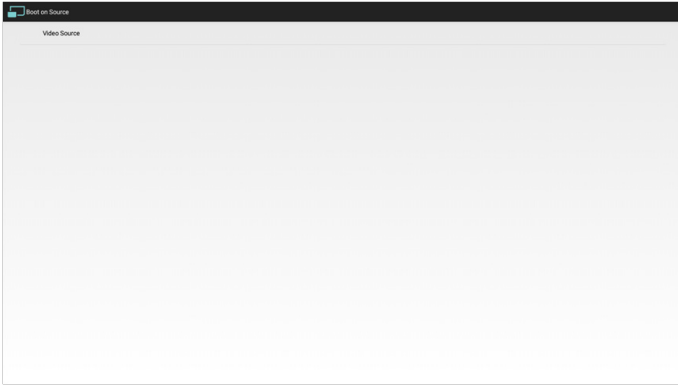

Open the page to select the APK for android boot on source.

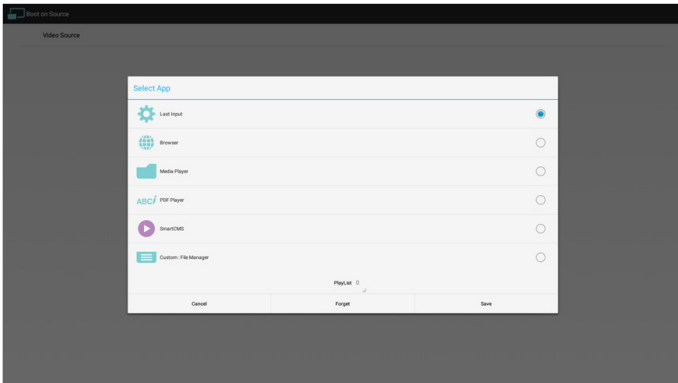

### 3.4.4. Network application

#### 1. Proxy

Enter the Host and Port of the proxy server:

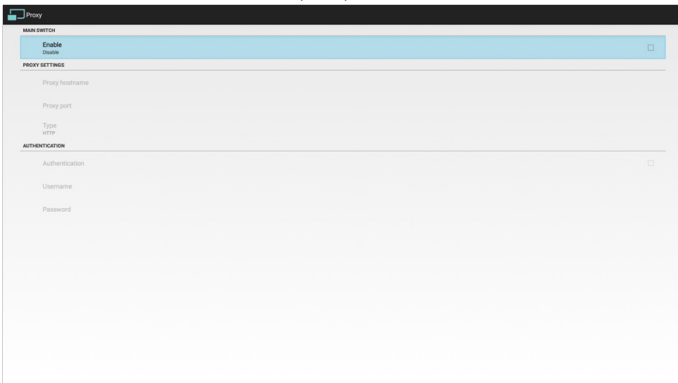

#### 2. Platform Web API

Enable / Disable Platform Web API.

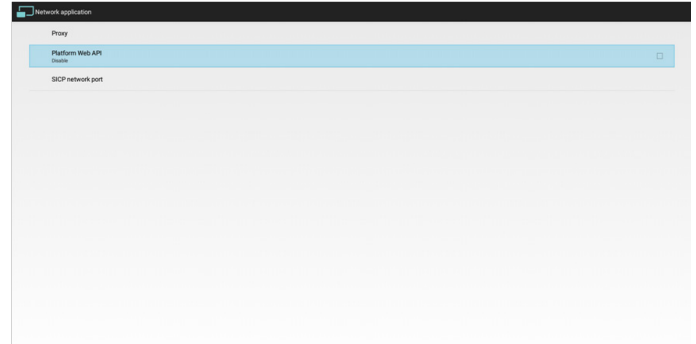

#### 3. SICP network port

Change SICP Network Port. Port range is 1025~65535.

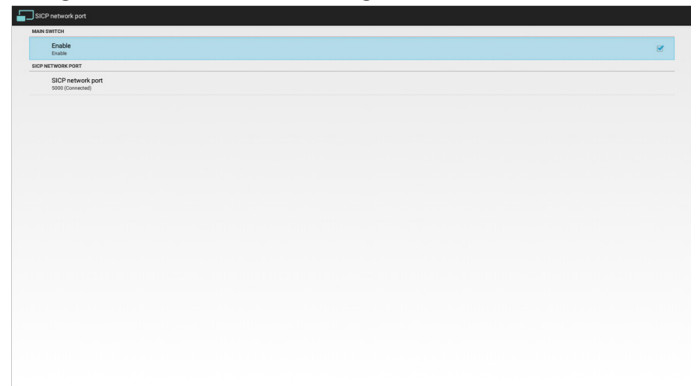

### 3.4.5. System Tools

System tools have 4 main functions.

#### (1) Clear Storage

The purpose is to clear all data in Philips folders. It has 4 modes to clean the data.

#### (2) Factory Reset

Factory Reset can recover to Factory default settings.

#### (3) Import & Export

The function of Import & Export system settings.

Note

##### 1). Saved file name:

- settings\_global.xml
- settings\_secure.xml
- settings\_system.xml
- signage\_settings.db
- AndroidPDMediaPlayerData.db
- AndroidPDPdfData.db
- AndroidPDUrlListData.db
- smartcms.db

##### 2). Will save to Philips folder in storage.

3). If no Philips folder exists in USB or SD card, it will be created automatically.

#### (4) Clone Media Files

Clone media file from internal, SD or USB Philips folder:

#### (5) External Storage

Lock/Unlock external storage.

### (6) Password

This is to allow user to change admin mode password (pin code)

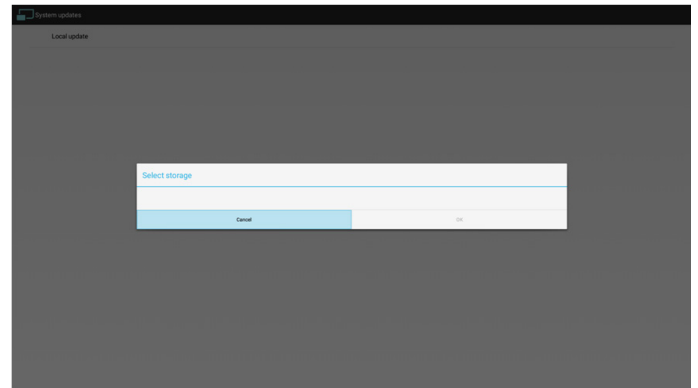
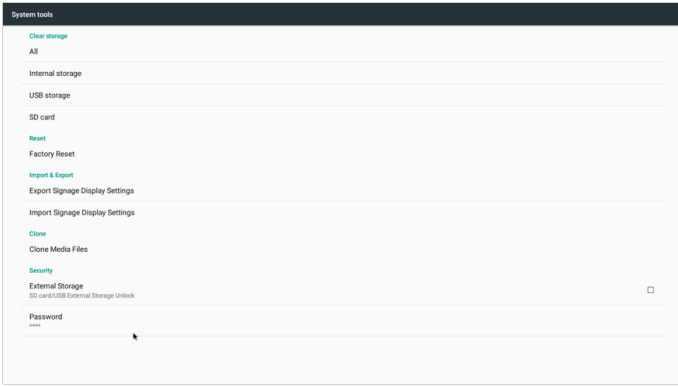

## 3.5. Display

User can modify the font size, can choose: Small/Normal/Large/Huge

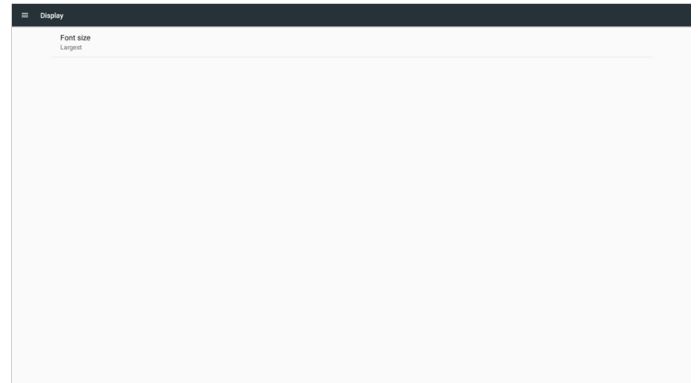

## 3.6. Storage

Display current OPS Android storage information.

Note

(1) User option key on RCU to show setting option

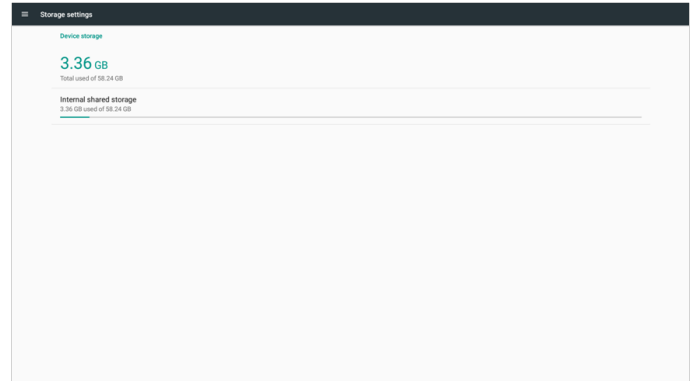

### 3.4.6. Misc.

#### 1. TeamViewer Support

Enable / Disable TeamViewer support.

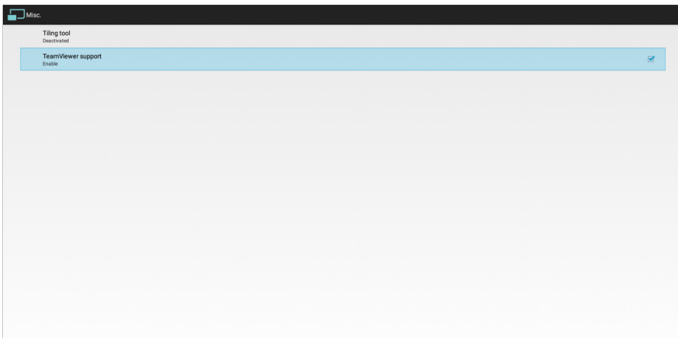

### 3.4.7. System update

#### 1. Local update

(1) Will automatically search update.zip in USB or SD card. If found will be shown up in list for user selection.

Note

- a. Only support Android Full image.
- b. File name should be update.zip
- c. The file should be located in root of storage.

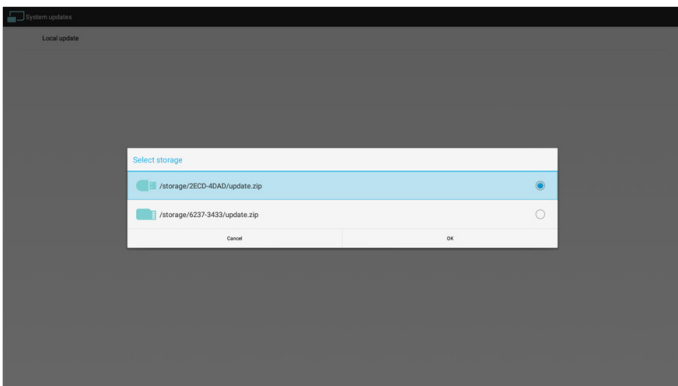

(2) After selecting update.zip file, system will restart and start updating.

(3) If update.zip is not found. The dialog is "no content". (OK button will be grayed.)



### SD CARD and USB STORAGE :

Need to insert SD card or USB, the information will show up total space and available of SD card or USB storage.

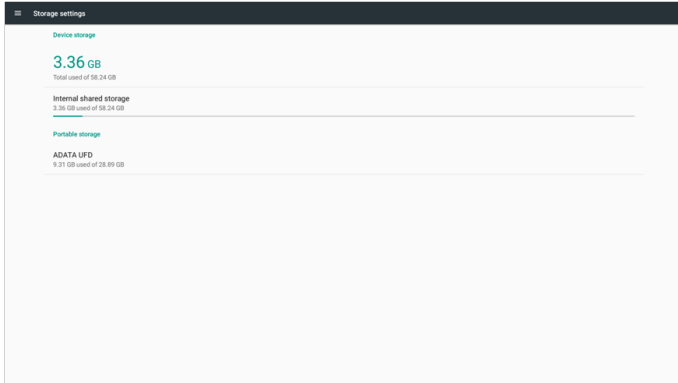

### Apps

Display applications information.

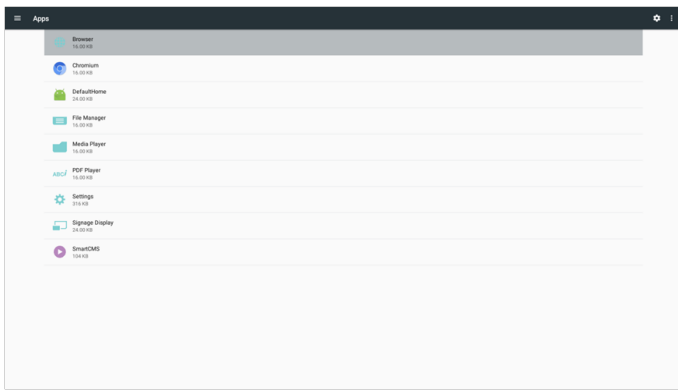

### 3.7. Security

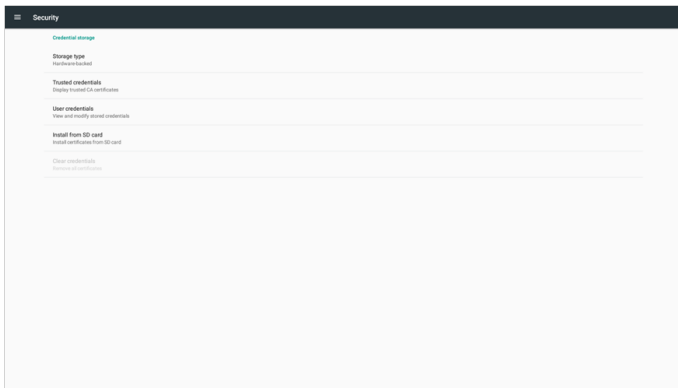

### 1. SIM card lock

Setup/Disable SIM PIN code.

Note:

- (1) Only show up when 4G module is connected

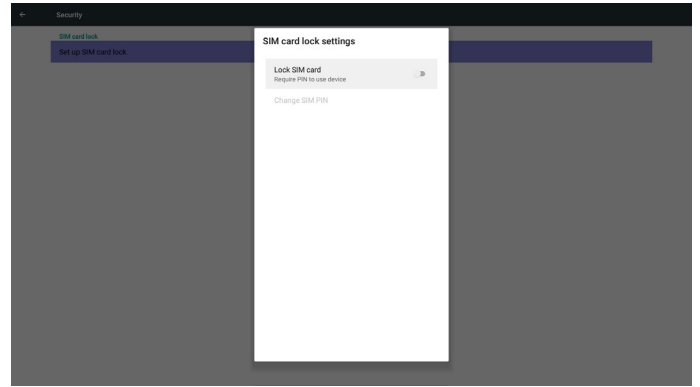

### 2. Credential storage

- (1) Storage type
- (2) Trusted credentials
- (3) Install from SD card
- (4) Clear credentials

### 3.8. Languages & input

Setup system language.

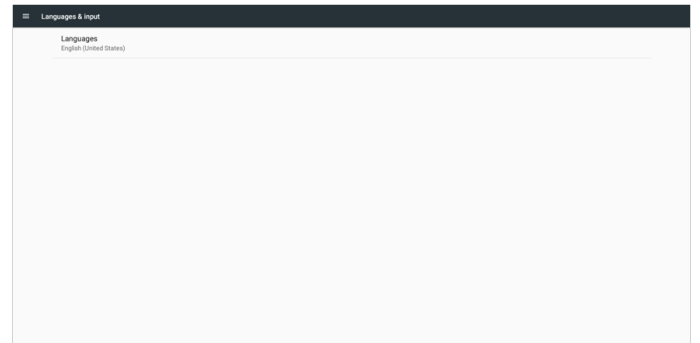

Add language in setup screen.

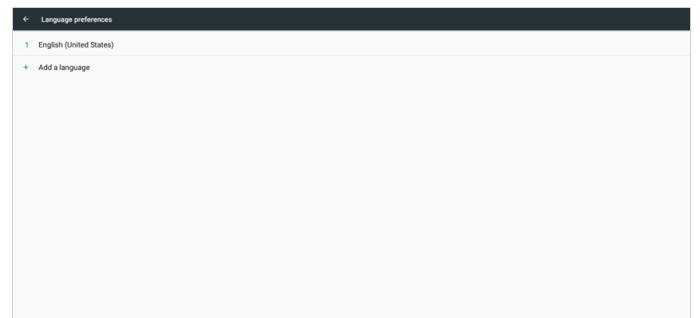

### 3.9. Date & time

Set up date, time and time zone. Setup time zone first and then go setup date & time. After time zone setup, then go setup date & time.



Note:

1. If "Automatic date & time" is enabled, the setup of date and time will be disabled and will use NTP server time.

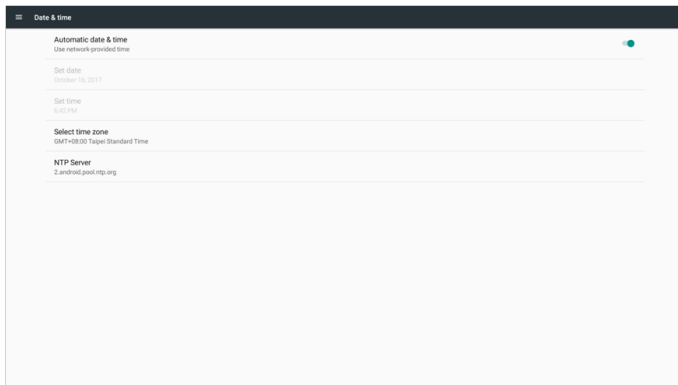

2. Disable "Automatic date & time", to setup the date and time. Android's date can be set from 2017/1/1 to 2037/12/31.

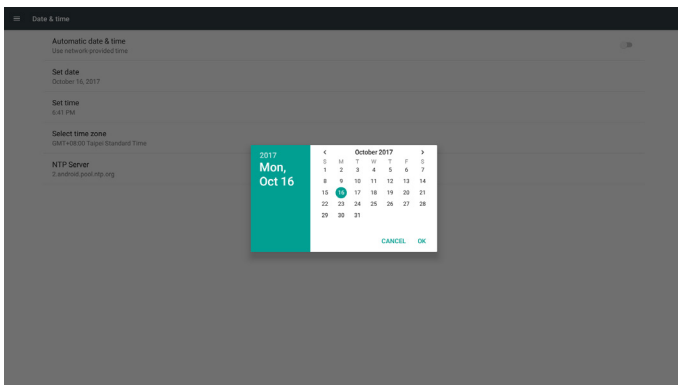

### 3.10. Developer options

Android developer options.

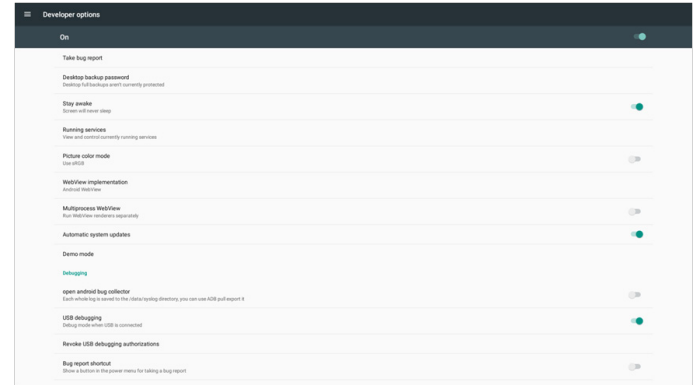

### 3.11. About

Main info in About:

- (1) System updates
- (2) Legal information
- (3) Android version
- (4) Kernel version
- (5) Build number

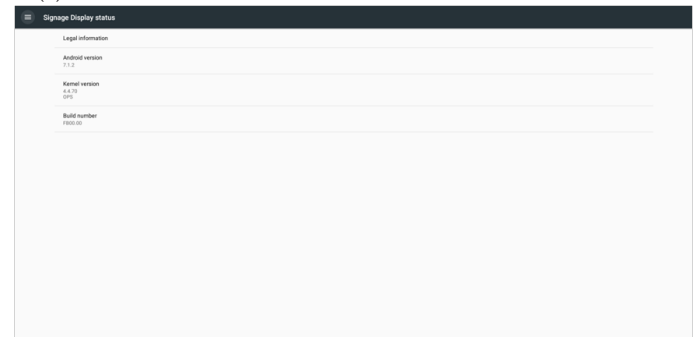

#### 3.11.1. System updates

1. Will automatically search update.zip in USB or SD card. Will be shown in list for user selection if found
2. After selecting update.zip file, PD will restart and start updating.
3. If update.zip is not found, the dialog is "no content" and the OK button will be grayed out.

Note:

- (1) Only support Android Full image.
- (2) File name should be update.zip.
- (3) The file should be located in root of storage.

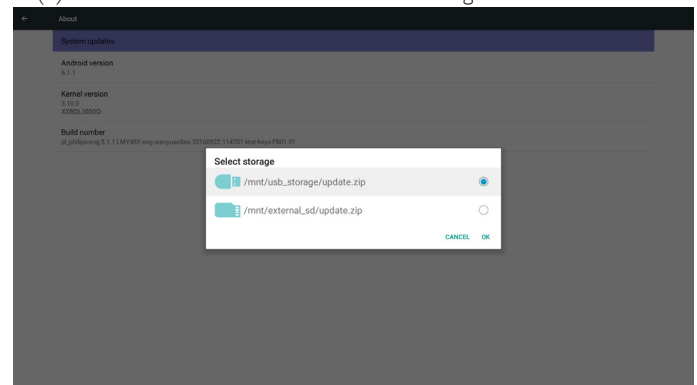

## 3.12. Legal Information

Show the open source licenses.

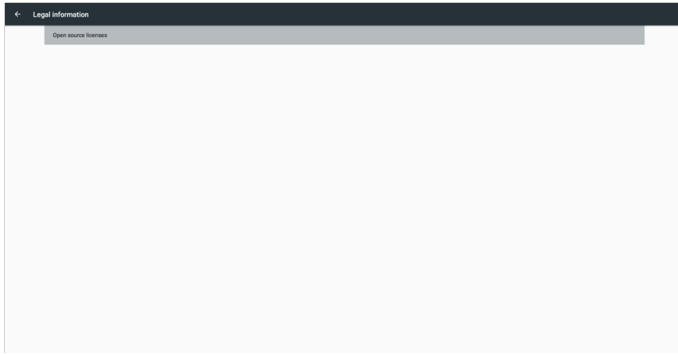

## 3.13. Supplementary

### 3.13.1. Quick Info

You can press keyboard "Win + 7,7" to startup quick info. (Or by left/right dragging, horizontal distance > screen width/5 to startup quick info when in Launcher for Touch host PD)

Quick info will show "Network" and "Monitor Information", as below:

Note:

Operation hours : It is updated every minute.

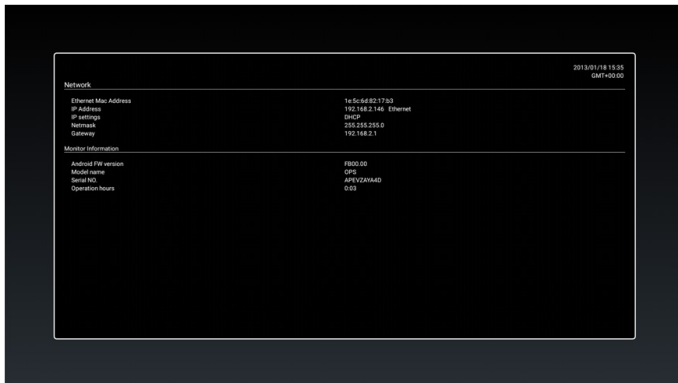

### 3.13.2. How to custom an Android boot animation?

#### 1. Overview

The Android boot animation is used script to load PNG files when the device boots. It is contained within an **uncompressed** zip file called **Bootanimation.zip**.

#### 2. Inside the Bootanimation.zip file

The Bootanimation.zip as follow:

- The image folder (Contains PNG images named in incremental numbers)
- The desc.txt file

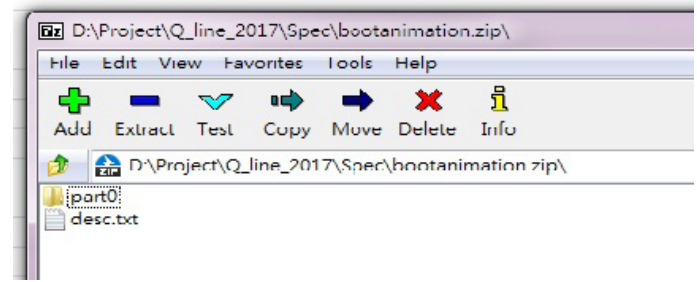

#### (1) The image folder

These contain PNG images named in numbers, starting from something like 0000.png or 0001.png and proceeding with increments of 1. There has to be at least one folder and there is no known upper limit to the number of folders.

#### (2) The desc.txt file

This file defines how the images in the folder(s) are displayed during the boot animation, in the following format:

- Width Height Frame-rate
- mode Loop delay-time Folder1
- mode Loop delay-time Folder2

An example of a desc.txt file is:

- 1920 1080 30
- p 1 0 part0
- p 0 0 part1

#### a. The first line

1920 and 1080 define the width and height of the screen resolution.

30 is the frame rate in fps (frames per second) i.e. number of images to display per second.

#### b. The second and third lines have a same format.

The first 'p' defines play mode is immediately stop playing when boot complete.

The number after 'p' defines repeat mode

- specifying 0 would make the part loop indefinitely till the device has boot complete.
- specifying 1 would make the part playback once.

The next number defines the delay time(ms). For example, if set 10, when all image files has been playback, system will delay 10ms.

The part0 and part1 are image folder name.

The above example, the boot animation will play at a resolution of 1920 by 1080 pixels, at a frame rate of 30 fps, starting with the contents of part0 folder and after playing them in one loop, switching to contents of part1 folder and playing them continuously till the device boot complete.

3. Zip file:

Select everything (image folders and desc.txt) inside the Bootanimzation folder and zip them into a new **uncompressed zip archive** using your favorite compression utility like 7zip or WinRAR and so on.

If using 7zip, set compression level to "Store"

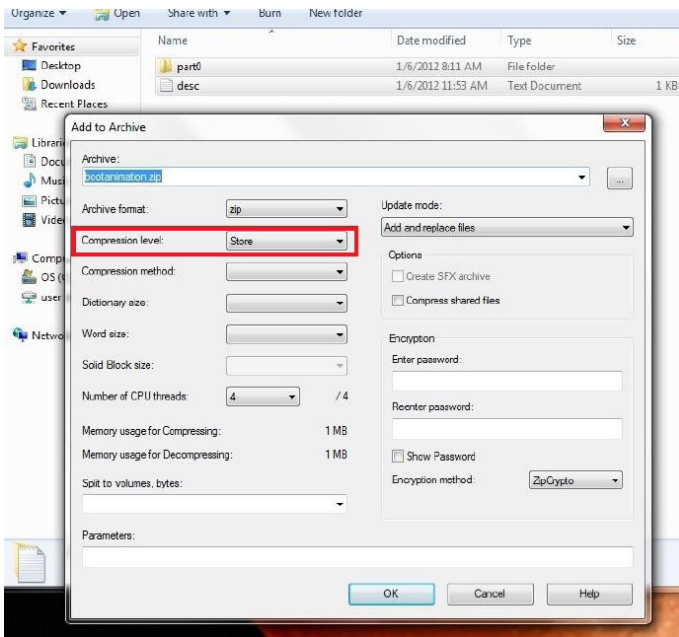

If using WinRAR, set "Compression method" to "Store"

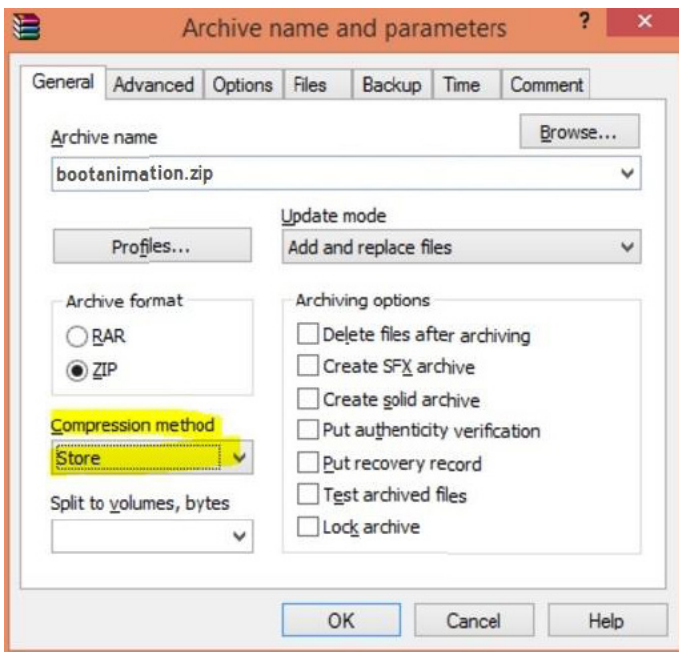

or else bootanimzation WON'T work

4. Apply the custom bootanimzation

Procedure:

- (1). Put your custom bootanimzation.zip file into external SD card or USB and plug into Phillips PD platform.
- (2.). Make sure the Logo option is enabled.  
Press Home key on RCU: OSD menu -> Configuration 2 -> Logo -> set "on"
- (3.). Press combination key "Home + 1888" on RCU to go to Admin mode:  
Settings -> Signage Display -> GENERAL SETTINGS -> Boot Logo

(4).The system will find the bootanimzation.zip in external SD card or USB automatically and copy it to /data/local

(5.) Once step 1~4 has been done, restart the system.The new customized boot animation should be displayed during boot time.

### 3.13.3.How to Install Android app?

There are 3 ways to install your own android app.

(a) Via File Manager in Admin Mode

1. If you have apk already
  - 1.1 copy your apk to USB disk or SD card, and then plug them into Philips Android Signage Display.
  - 1.2 Go to Admin Mode > Apps > File Manager
  - 1.3 Using File Manager and find out your apk and then you can install. Just press "ok" on the selected apk.
2. Download apk by Chromium browser, and then go to <internal storage path>/Download/ by File Manager.
  - 2.1 The rest of steps is the same as above. Please note, each model may have different <internal storage path>.

(b) Via Adb Shell

1. Make sure that your PC can connect to Philips Android Signage Display using adb.
2. Prepare your apk in a folder (for example, C:\apkfolder) on PC.
3. Execute the following instruction by command line tool.  
C:\apkfolder> adb install -r apk\_name.apk

(c) Via Customized Intent

1. If you develop an apk which can download any android app, then your apk can issue a customized intent.
2. Giving the apk name and the path it was stored.The system will help you to install by program.

Description	Intent	Parameters	
Sw Update	php.intent.action.UPDATE_APK	filePath	The absolute file path including the file name.
		Keep	Indicate that you want to keep the file or not after updating.The default value is false.
		packageName	The target package you want to launch automatically after updating.
		activityName	The target activity you want to launch automatically after updating. But if current top activity is not activityName, nothing happened.

For example,

```
Intent intent = new Intent();
intent.setAction("php.intent.action.UPDATE_APK");
intent.putExtra("filePath", "/sdcard/Download/apk_name.apk");
intent.putExtra("keep", true);
intent.putExtra("packageName", "com.example.apk_name");
intent.putExtra("activityName", "com.example.apk_name.MainActivity");
sendBroadcast(intent);
```

### 3.13.4. How to connect with platform Web API?

PD has a local web server to provide Web API for customer getting PD information in JSON format.

1. APIs specifications
  - Protocol: HTTP
  - Method: GET
  - Domain: localhost
  - Port: 9988
  - URI: /platform/getinfo
2. API Request URL
  - http://localhost:9988/platform/getinfo
3. API Response
  - Status

Status	Code	Description
Success	0	Request success
Error	1	Request failure

- Result in JSON format
  - interfaces: list all of network interface's MAC address
    - family: the address-family within an IPv4 or IPv6
    - mac: network interface's MAC address
    - ip: network interface's IP address
  - currentip: current IP address of device
  - sn: serial number of device
  - model: model name of device
  - version: version of Web API
- JSON sample

```
{
  status: "success",
  code: 0,
  decription: "success",
  result:
  {
    "version": "1.0",
    "currentip": "172.17.3.4",
    "sn": "123456",
    "model": "PDMmodelName",
    "interfaces": [
      {
        "family": "IPv6",
        "ip": "fe80::84ea:d74b:1167:aa69",
        "mac": "a4:4e:31:9c:79:e0"
      },
      {
        "family": "IPv4",
        "ip": "172.17.3.4",
        "mac": "a4:4e:31:9c:79:e0"
      }
    ]
  }
}
```

## 4. USB device compatibility

### USB Multimedia Codec Formats

Video Decode						
Type	Video Codec	Container	Decode	Encode	Channel	Remark
MPEG1/2	MPEG1/2	File Format: DAT, MPG,VOB,TS	V			Supported Image Size:48x48pixels to 1920x1088pixels Maximum Frame Rate:30fps Maximum Bit Rate:80Mbps Audio Codec: MP2, MP3
MPEG-4	MPEG4	File Format: AVI, MKV, MP4, MOV, 3GP	V			Supported Image Size:48x48pixels to 1920x1088pixels Maximum Frame Rate:30fps Maximum Bit Rate:38.4Mbps Audio Codec: MP2, MP3, AAC,PCM,  (1) Not support MS MPEG4 v1/v2/v3 (2) Not support GMC(global motion compensation)
H.263	H.263	File Format: 3GP, MOV, MP4	V			Supported Image Size:SQCIF(128x96), QCIF(176x144), CIF(352x288),4CIF(704x576) Maximum Frame Rate:30fps Maximum Bit Rate:38.4Mbps Audio Codec: MP3 (1) Not support H.263+
H.264	H.264	File Format: AVI, MKV, MP4, MOV, 3GPTS, FLV	V			Supported Image Size:48x48pixels to 1920x1088pixels Maximum Frame Rate:30fps Maximum Bit Rate:57.2Mbps Audio Codec: MP2, MP3, AAC, PCM  (1) Not support MBAFF
GOOGLE VP8	VP8	File Format: WEBM	V			Supported Image Size:48x48pixels to 1920x1088pixels Maximum Frame Rate:30fps Maximum Bit Rate:38.4Mbps Audio Codec: Ogg Vorbis
Motion JPEG	MJPEG	File Format: AVI, MOV	V			Supported Image Size:48x48pixels to 1920x1088pixels Maximum Frame Rate:30fps Maximum Bit Rate:38.4Mbps Audio Codec: MP2, MP3, AAC, PCM

### Audio Decode

Type	Audio Codec	Container	Decode	Encode	Channel	Remark
MPEG Audio	MPEG1/2/2.5 Audio Layer1/2/3	Decode: MP1, MP2, MP3	V		2	Bit Rate: 8kbps~320Kbps, CBR and VBR Sampling Rate: 8KHZ~48KHZ
Windows Media Audio	WMA Version 4,4.1, 7, 8, 9, wmapro	Decode: WMA	V		2	Bit Rate: 8kbps~320Kbps Sampling Rate: 8KHZ~48KHZ Non-support WMA Pro,lossless and MBR
AAC Audio	MAIN,ADIF ,ATDS Header AAC-LC and AAC-HE	File Format: AAC, M4A	V		5.1	Bit Rate: N/A Sampling Rate: 8KHZ~48KHZ

## Image Decode

Type	Image Codec	Photo	Decode	Encode	Channel	Remark
JPEG	JFIF file format 1.02	File Format: JPG, JPEG	√			Decode: Resolution 48X48 to 8176X8176  (1) Not Support Non-interleaved Scan (2) Software support SRGB JPEG (3) Software support Adobe RGB JPEG
BMP	BMP	File Format: BMP	√			MaximumSupported Image Size:4096x4096 pixels
GIF	GIF	File Format: GIF	√			Resolution No Restriction
PNG	PNG	File Format: PNG	√			Resolution No Restriction

### NOTES:

- Sound or video may not work if the contents have a standard bit rate/frame rate above the compatible Frame/sec listed in the table above.
- Video content with a Bit rate or Frame rate larger than the rate specified in the table above can cause choppy video during playback.

## 5. Cleaning

### Cabinet Cleaning Instructions

#### **Before cleaning, please unplug from power source!**

- If the cabinet becomes dirty, wipe the cabinet with a soft, dry cloth.
- If the cabinet is extremely dirty, soak a lint-free cloth in a mild detergent solution. Wring the cloth to remove as much moisture as possible. Wipe the cabinet. Use another dry cloth to wipe over until the surface is dry.
- Do not allow any water or detergent to come into contact with the surface of the OPS Module. If water or moisture gets inside the unit, operating problems, electrical and shock hazards may result.
- Do not scratch or hit the cabinet with fingers or hard objects of any kind.
- Do not use volatile substances such as insect sprays, solvents and thinners on the cabinet.
- Do not place anything made from rubber or PVC near the cabinet for any extended periods of time.
- Make sure the ventilation holes are free from dust or other objects, in order for free air-flow.



## 6. Technical Specifications

### In/Out Terminals:

Item		Specifications
RS232C	2.5mm Phone jack x 1	RS232C In/Out
RJ-45	RJ-45 Jack x 1 (8 pin)	10/100/1000 LAN Port
Displayport out	Displayport Jack x 1 (20 pin)	Digital RGB:TMDS (Video + Audio) MAX: Video - 720p, 1080p, 1920 x 1080/60 Hz (WUXGA) Audio - 48 KHz/ 2 Channel (L+R) Supports LPCM only
USB Input	USB2.0 TypeA x1 USB3.0 TypeA x1	USB2.0 USB3.0

### General:

Item	Specifications
Power Input	DC 12V - 19V (From OPS Slot)
Power Consumption (Max)	20 W When USB maximum loading
Power Consumption (typ.)	<10 W
Power Consumption (Off)	<0.5 W
Dimensions [W x H x D]	200.0 x 30.0 x 135.0 mm
Weight	0.6 Kg
Gross Weight	1 Kg

### Environmental Condition:

Item		Specifications
Temperature	Operational	0 ~ 40°C
	Storage	-20 ~ 60°C
Humidity	Operational	20 ~ 80% RH (No condensation)
	Storage	5 ~ 95% RH (No condensation)
Altitude	Operational	0 ~ 3,000 m
	Storage / Shipment	0 ~ 9,000 m



2018 © Koninklijke Philips N.V. All rights reserved.

Philips and the Philips Shield Emblem are registered trademarks of Koninklijke Philips N.V. and are used under license from Koninklijke Philips N.V.

Specifications are subject to change without notice.