

PTC500S

User Manual



IMPORTANT NOTICE

- ✧ PLEASE READ THE INSTRUCTIONS IN THIS MANUAL BEFORE INSTALLING THE PTC500S TRACKING CAMERA.
- ✧ DO NOT DISASSEMBLE OR MODIFY THE ITEMS BY YOURSELF. CONTACT THE DEALER FOR HELP WHEN THE ITEMS IS FAILED TO WORK.
- ✧ CONNECT THE DEVICES WITH PROPER CABLES.
- ✧ TO REDUCE RISK OF ELECTRIC SHOCK ONLY USE INDOORS.
- ✧ AVOID INSTALLING AT HUMID ENVIRONMENT.

Federal Communication Commission Interference Statement



NOTE: This equipment has been tested and found to comply with the limits for a Class A digital device, pursuant to part 15 of the FCC Rules. These limits are designed to provide reasonable protection against harmful interference when the equipment is operated in a commercial environment. This equipment generates, uses, and can radiate radiofrequency energy and, if not installed and used in accordance with the instruction manual, may cause harmful interference to radio communications. Operation of this equipment in a residential area is likely to cause harmful interference in which case the user will be required to correct the interference at his own expense. FCC Caution: Any changes or modifications not expressly approved by the party responsible for compliance could void the user's authority to operate this equipment.

This device complies with part 15 of the FCC Rules.

Operation is subject to the following two conditions:

- (1) This device may not cause harmful interference, and
- (2) this device must accept any interference received, including interference that may cause undesired operation.

Warning: This is a class A product. In a domestic environment this product may cause radio interference in which case the user may be required to take adequate measures

European Community Compliance Statement (Class A)



This product is herewith confirmed to comply with the requirements set out in the Council Directives on the Approximation of the laws of the Member States relating to Electromagnetic Compatibility Directive 2014/30/EU.

Warning - This is a Class A product. In a domestic environment this product may cause radio interference in which case the user may be required to take adequate measures to correct this interference.

DISCLAIMER

No warranty or representation, either expressed or implied, is made with respect to the contents of this documentation, its quality, performance, merchantability, or fitness for a particular purpose. Information presented in this documentation has been carefully checked for reliability; however, no responsibility is assumed for inaccuracies. The information contained in this documentation is subject to change without notice.

In no event will AVer Information Inc. be liable for direct, indirect, special, incidental, or consequential damages arising out of the use or inability to use this product or documentation, even if advised of the possibility of such damages.

TRADEMARKS

“AVer” is a trademark owned by AVer Information Inc. Other trademarks used herein for description purpose only belong to each of their companies.

COPYRIGHT

©2019 AVer Information Inc. All rights reserved.

All rights of this object belong to AVer Information Inc. Reproduced or transmitted in any form or by any means without the prior written permission of AVer Information Inc. is prohibited. All information or specifications are subject to change without prior notice.

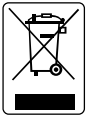

The mark of Crossed-out wheeled bin indicates that this product must not be disposed of with your other household waste. Instead, you need to dispose of the waste equipment by handing it over to a designated collection point for the recycling of waste electrical and electronic equipment. For more information about where to drop off your waste equipment for recycling, please contact your household waste disposal service or the shop where you purchased the product.

[별표 4]

사용자안내문

사 용 자 안 내 문

이 기기는 업무용 환경에서 사용할 목적으로 적합성평가를 받은 기기로서 가정용 환경에서 사용하는 경우 전파간섭의 우려가 있습니다.

※ 사용자 안내문은 “업무용 방송통신기자재”에만 적용한다.

CONTENTS

INTRODUCTION	1
Package Contents	1
Product Overview	2
Dimension.....	2
Remote Controller	3
CONNECTIONS	4
Device Connections.....	4
RS232 Pin Definition	5
MODE INTRODUCTION	6
Wide Area Mode	6
Stage and Segment Mode	7
WEB SETUP	8
Make a Connection to PTC500S via Browser.....	8
Make a Connection to PTC500S via AVer IPCam Utility.....	10
Enable Tracking Function	11
Setup Object Viewing Dimension	12
Tracking Mode Instruction	13
Wide Area Mode	14
Setup Priority Zone	14
Setup Shielded Zone.....	15
Stage Mode	16
Setup Effective Zone	16

Setup Shielded Zone.....	17
Setup Target Tracking Body	18
Segment Mode	19
Setup Effective Zone	19
Setup Shielded Zone.....	22
Setup Target Tracking Body	23
Preset Setup.....	24
Firmware Update	25
Using RTSP connect to Camera.....	25
OSD SETUP.....	26
Before You Begin.....	26
For the First Time Use	26
Trigger OSD Menu	26
Setup IP Address.....	27
OSD Tree Map.....	29
Main	29
Tracking	29
Camera	30
Camera ID	30
DHCP	30
Static IP.....	31
PTZ Camera	32

Video Format.....	35
Advanced Setting	37
Preset.....	37
Language	39
Profile	39
Factory Default.....	40
Information	40
Hot Key	41
FAQ	42

INTRODUCTION







AVer PTC500S is a professional tracking camera which can be wide area, stage or segment mode depended on user's subject target. The PTC500S use body motion and image analysis algorithm to tracking target; the target subject no need to wear any signal transmit device. The PTC500S can communicate with recording system through RS232, RS485 or network interface. The PTC500S has stable system, easy to use, and suitable for classroom, meeting room, and any lecture or course environment.

Package Contents

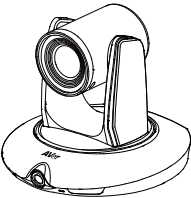
The following items are included in the package. Please check if each item is available and confirm if there are damage before using.

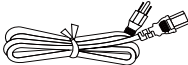
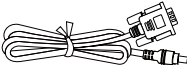
[Note]

1. Do not disassemble or modify the items by yourself. Contact the dealer for help when the items is failed to work.
2. Store the items in a dry place away from moisture.

PTC500S unit	Power adapter	Power cord	RS-232 to D-Sub 9 cable
			
Battery	Quick Guide	Remote Control	
			

[Note] The power cord will vary depending on the standard power outlet of the country where it is sold.

Product Overview

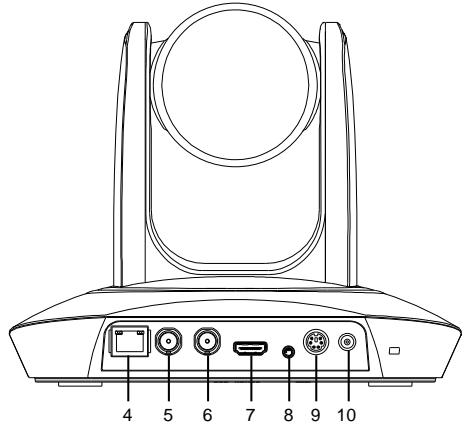
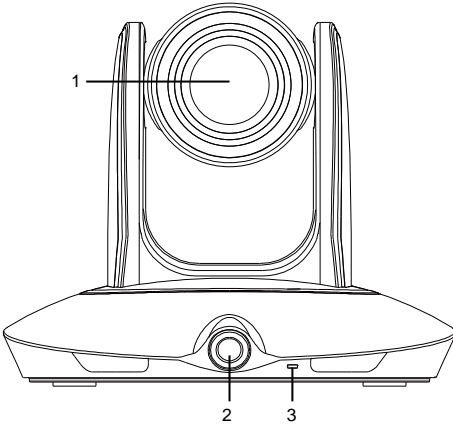

- 1. PTZ camera
- 2. Panoramic camera
- 3. Power indicator
- 4. RJ-45 port
- 5. 3G-SDI 2 port(Panoramic view)

- 6. 3G-SDI 1 port(PTZ view)
- 7. HDMI port(PTZ view)
- 8. Audio in port*
- 9. RS-232 port
- 10. Power jack

*Line input level: 1Vrms(max.)

Dimension

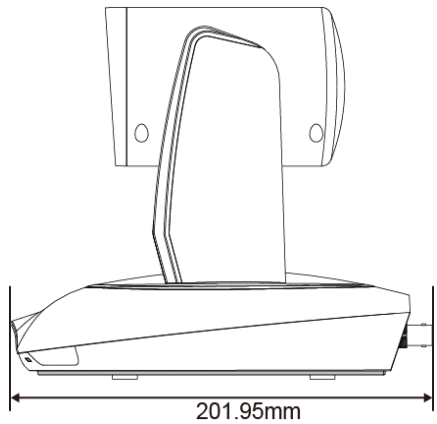
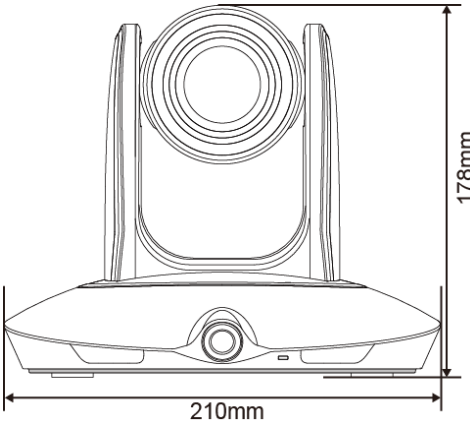

Remote Controller

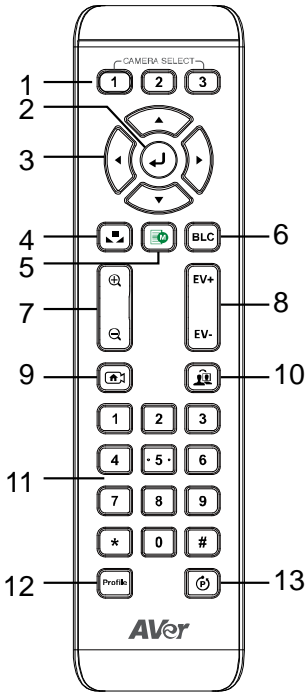

1. Camera select

[Note] Only channel No.1 is available.
Before you use remote, please press channel 1 first.

2. Enter

3. Camera direction control

4. White balance

5. OSD menu

6. Back light control

7. Zoom in/out

8. Exposure compensation

9. Back to zero position((home preset)

[Note] Press and hold for **3** seconds to turn on or turn off the PTC500S unit.

Only support at PTC500S FW version **0.0.1000.08** and above.

10. Tracking on/off

11. Number buttons

12. Profile

13. Preset

CONNECTIONS

Device Connections

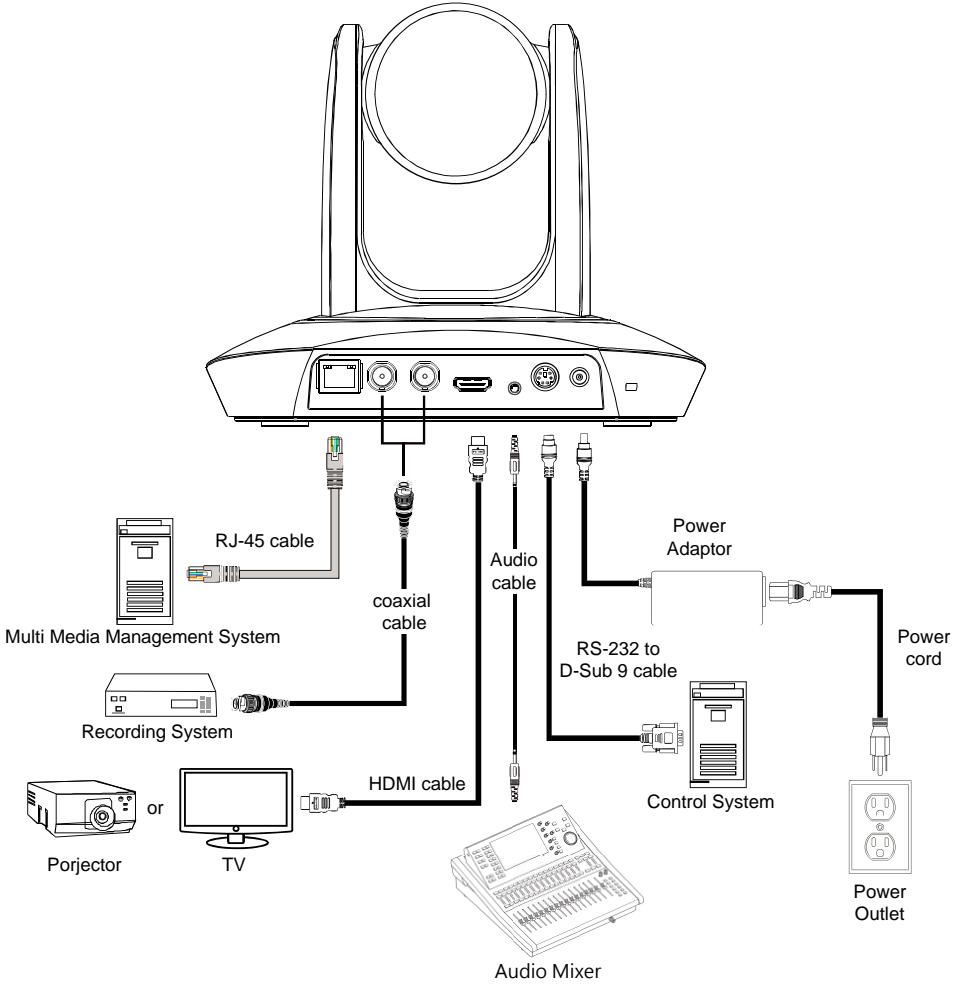

RS232 Pin Definition

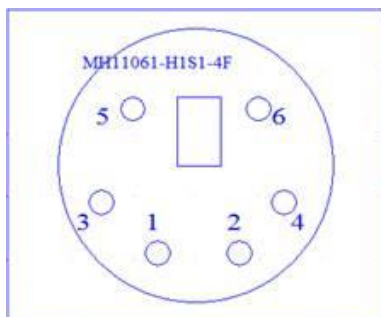

Pin	Definition
1	RS232_DTR
2	RS232_DSR
3	N.C.
4	RS232_TXD
5	GND
6	RS232_RXD

MODE INTRODUCTION

Wide Area Mode

❖ Application

- This mode is suitable for teacher or lecturer tracking in normal classroom. The algorithm is based on face detection.
- Regardless of the target close to or away from PTC500S, the tracking camera will automatically zoom in/out to maintain the appropriate size and proportion.
- If the tracking target is locked, PTC500S will not be affected by the other moving objects.

❖ Limitation

- This mode is easily affected by the brown objects or the color similar to skin. Things like cartons and wood furniture.
- It should be used in bright environment. If the light is not enough, it will cause PTC500S unable to distinguish the target face and lead to the tracking failure.
- It could not be used on the environment with high bright contrast. For example, the environment is with IFP or projectors. When the target enters or leaves the high bright contrast zone, it is risky for PTC500S to lose the tracking target.

- **Install height range (from floor):** 2 ~ 3m; **2.4m** is suggested.
- **Distance range to podium:** 4~15m; **8m** is suggested.
- **Position:** Center of class room.

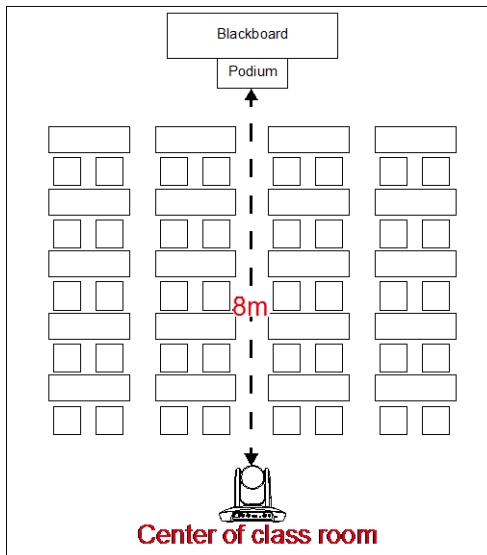

Stage and Segment Mode

✧ Application

- It's suitable for complicate environment. It's the remedy for teacher mode. Due to absolute motion tracking, PTC500S will not be affected by the color of wood furniture or the high bright contrast.
- Suitable for only one person in the tracking zone.

✧ Limitation

- Tracking is only available for horizontal movement. It will not auto zoom in/out for target close to or leaving away from PTC500S
- Due to absolute motion checking, it is unable to check who the target is or who the interference is. It doesn't have anti-interference ability.
- Due to the FOV limit, the tracking zone is only available within 120 degrees.
- Distance limitation <15M

- **Install height range (from floor):** 2 ~ 3m; **2.4m** is suggested.
- **Distance range to podium:** 4~15m; **8m** is suggested.
- **Position:** Center of the room.

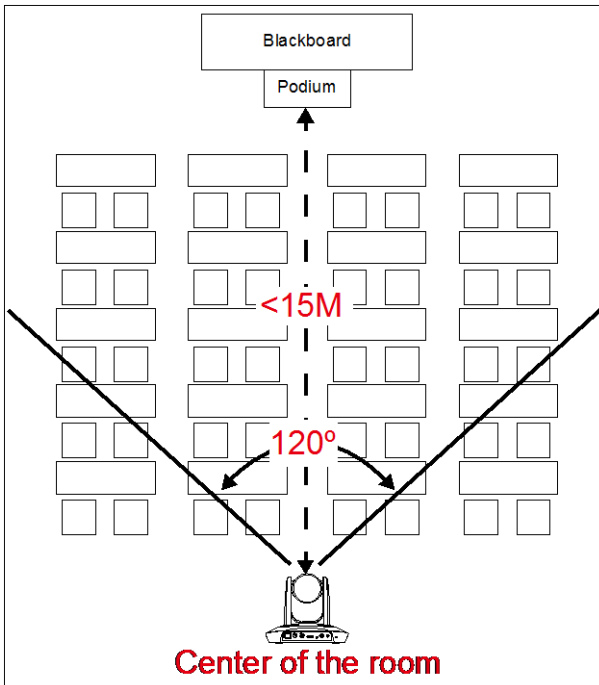

WEB SETUP

Make a Connection to PTC500S via Browser

1. **Find the IP address of PTC500S:** call out OSD menu of PTC500S. Use ▲ and ▼ buttons on remote controller to go to “Information” to find the IP address information.

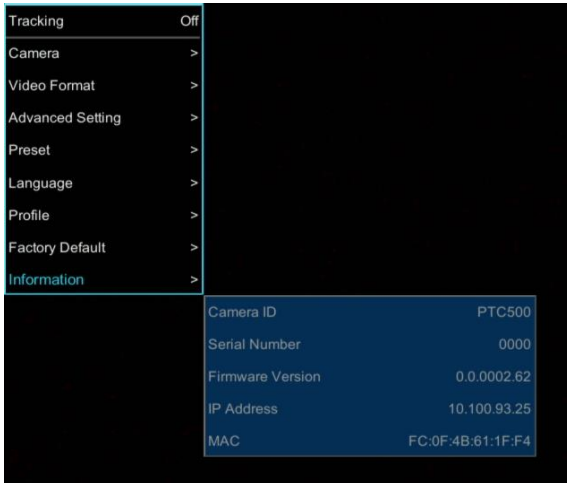

2. Open the browser on your PC and enter the IP address of PTC500S.
3. Enter the password of PTC500S to login. The default password is “**admin**”.



4. After login, User should see the main interface of PTC500S.

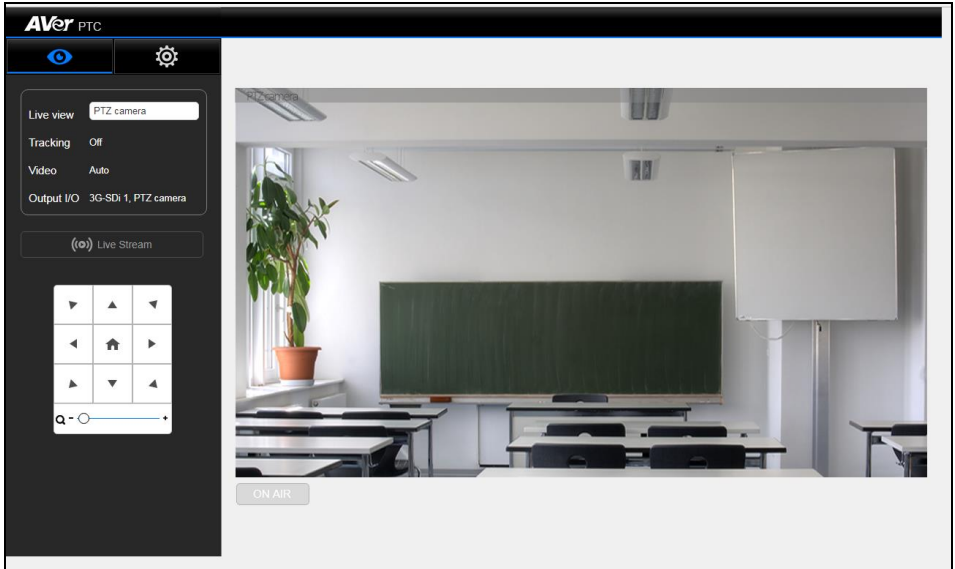

Make a Connection to PTC500S via AVer IPCam Utility

[Note] The PTC500S FW version 0.0.1000.08 and above supports IPCam Utility application.

To find the IP address of your cameras, you can execute the IPCam Utility installer. Follow the below steps to find the IP address of camera.

1. Download the IPCam Utility from <http://www.aver.com/download-center>.
2. Run the IPCam Utility.
3. Click Search, and all available devices will be listed on the screen.
4. Select a camera from the list.
5. The corresponding fields of IP address will display.
6. Double-click on the IP address of camera from the list can connect to camera through the browser.

[Note] If IPCam utility cannot find the camera, please check following:

1. Please make sure the Ethernet connection of camera is well connected.
2. The camera and PC (IPCam utility) are in the same LAN segment.

Network Device: Realtek PCIe GBE Family Controller [Search]

Login: User ID [] Password []

Network Setting | Date/Time Setting | Maintenance | Import/Export Config

Search Result: [Select All]

No.	Status	Progress	Model Name	Device Name	FW version	IPv4 Address	MAC Address	IPv6 Address
<input type="checkbox"/> 1	Working		PTC500S	PTC500S	0.0.1000.08	10.100.93.57:80	00:68:53:45:12:77	[]:80
<input type="checkbox"/> 2	Working		PTC500S	PTC500S	0.0.1000.08	10.100.93.56:80	64:cf:d9:a8:98:92	[]:80
<input type="checkbox"/> 3	Working		PTC500S	PTC500S	0.0.1000.08	10.100.93.59:80	50:33:8b:99:0d:18	[]:80

Settings: Device Name: [] Start IP Address: [. . .] End IP Address: [. . .] Subnet Mask: [. . .] Gateway: [. . .] Primary DNS: [. . .] Secondary DNS: [. . .]

DHCP Static IP

*Auto search will start after settings changed!
 Don't start auto search this time!

[Apply]

Enable Tracking Function

Turn on and off the tracking function. Select  > **Tracking setting** > **Tracking on**.

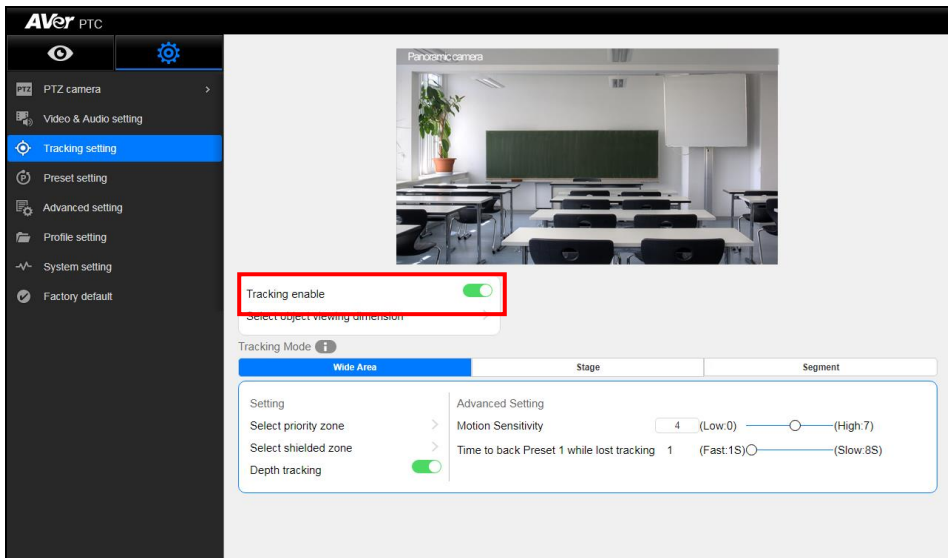

Setup Object Viewing Dimension

Set the size of tracking object on the screen. Aim the intersection of blue line can get best curacy of tracking. The illustration shows the minimum request. Set the person proportion more than the illustration. If target proportion is smaller than the photo, it may cause the tracking failure.

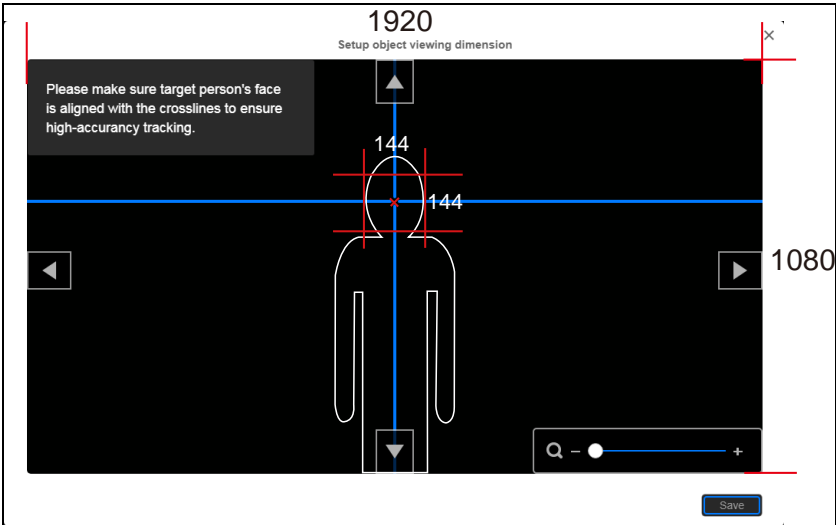

To set the object size for tracking select  > **Tracking setting** > **Setup object viewing dimension**
(Also see [Object Viewing Dimension Setting](#) chapter).

Use ▲, ▼, ◀, ▶ and zoom in/out to adjust object size. Then, click "**Save**" to save the setting.

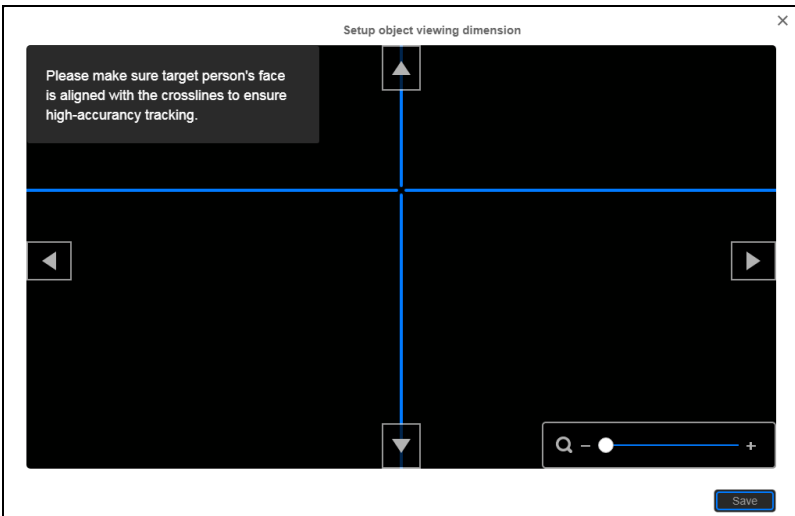

Tracking Mode Instruction

View the each tracking mode's brief instruction, feature, and use environment.

Select  > **Tracking Setting** > **Tracking Mode**  to view tracking mode instruction.

Tracking mode instructions ×			
	Wide area	Stage	Segment
Introduction	Accurately track a chosen target anywhere in a crowd.	Track target in all lighting conditions with high accuracy.	Tracking by segment: stay fixed on one area until target moves to next area.
Features	The person tracking function captures every movement.	Horizontal continuous high-accuracy target tracking.	Track up to 4 fixed locations based on target's position.
Mostly used for	<ul style="list-style-type: none">• Classrooms• Presenters moving through a crowd.	<ul style="list-style-type: none">• Stage presentations• Stage performances• Target projectors behind	<ul style="list-style-type: none">• After school podium.• Classroom podium.• Multiple panels need to be displayed.



Wide Area Mode

The PTC500s will start tracking when object enter the priority zone and the face of object is detected.

Setup Priority Zone

If PTC500S detects motions in the defined zone and PTC500S will be triggered to track. If priority zone doesn't setup, then, all the panoramic view will be the default active zone.

[Note] The screen of priority zone setting is based on panoramic camera view.

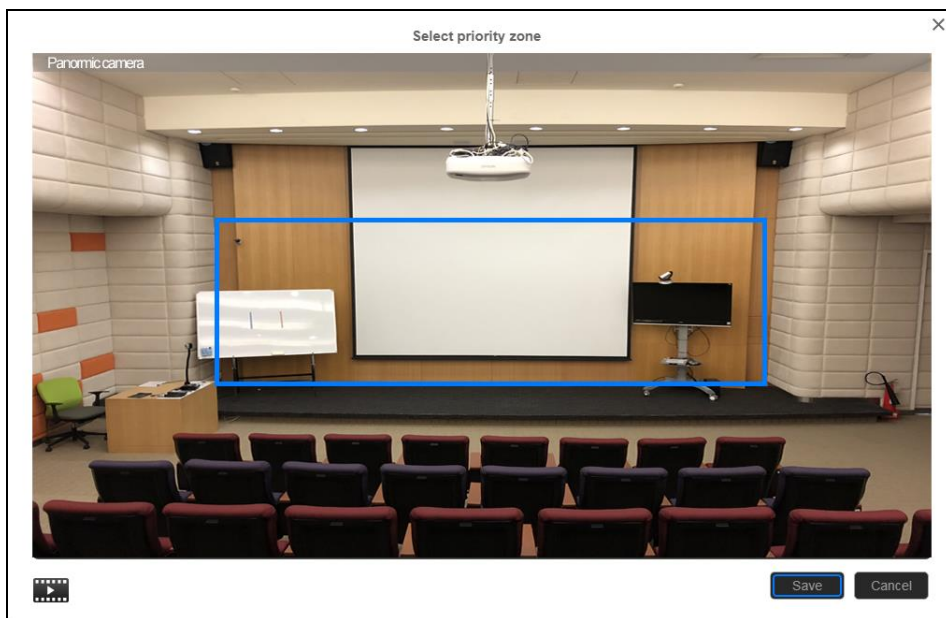

1. Select  > **Tracking setting** > **Wide Area** > **Select priority zone**.
2. An online tutorial will display. User can watch to learn how to setup tracking zone. Click **Skip** to stop tutorial. To watch again, select  to play online tutorial.
3. In Select priority zone screen, drag and select the area that wants to be tracking (a blue frame will show on screen). To re-select the area, just drag and select another wanted area.
4. Click **Save** to save the setting.



Setup Shielded Zone

Define the area that user doesn't want camera to track. The shield zone should be within the active zone. 8 shield zones can be set.

[Note] The screen of shielded zone setting is based on panoramic camera view.

1. Select  > **Tracking setting** > **Wide Area** > **Select shielded zone**.
2. An online tutorial will display. User can watch to learn how to setup shield zone. Click **Skip** to stop tutorial. To watch again, select  to play online tutorial.
3. In Shielded tracking zone screen, click the “+” and select the area in tracking zone that don't want to be tracking (a gray block will show on screen). For example: Shielded the projector screen and TV that may influence the tracking. To delete the shield zone area, click “-” and select the shield to delete it. Or select “**Reset Shields**” to delete all shields.
4. Select “**Save**” to save the setting.

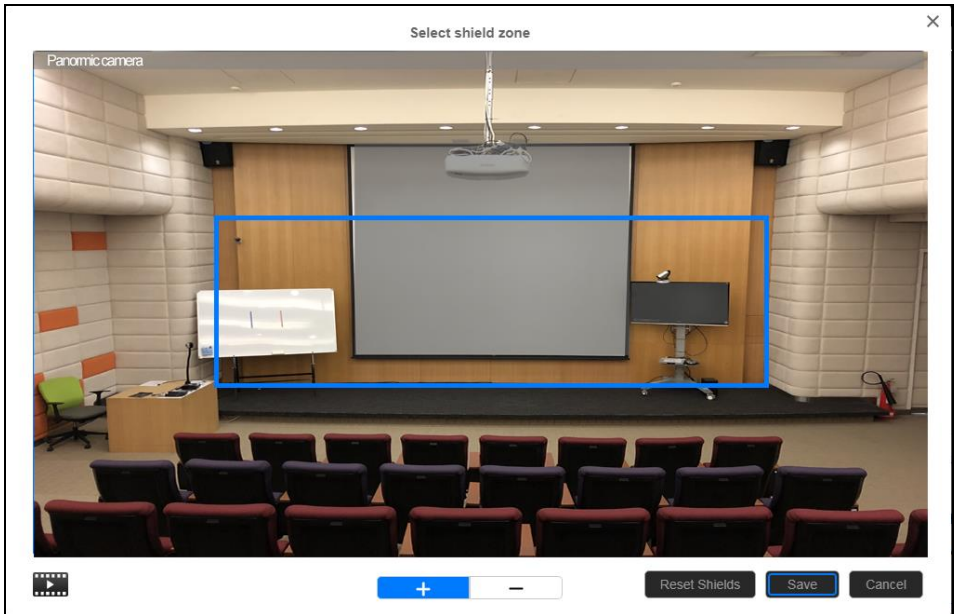



Stage Mode

The PTC500S will start tracking when there is an object moving in effective zone.

Setup Effective Zone

If PTC500S detects motions in the defined zone and PTC500S will be triggered to track. If tracking zone doesn't setup, then, all the panoramic view will be the default active zone.

[Note] The screen of effective zone setting is based on panoramic camera view.

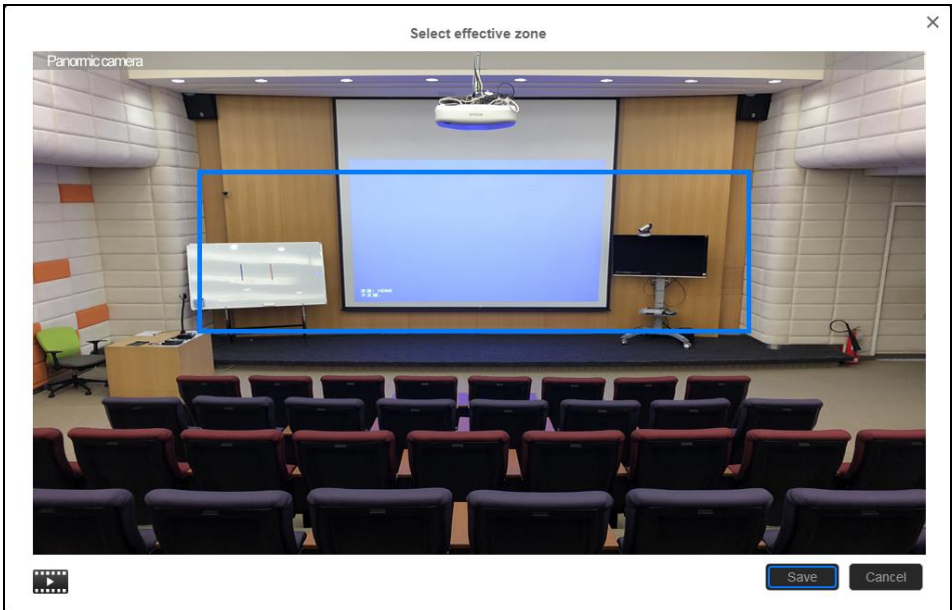

1. Select  > **Tracking** > **Stage** > **Select effective zone**.
2. An online tutorial will display. User can watch to learn how to setup tracking zone. Click **Skip** to stop tutorial. To watch again, select  to play online tutorial.
3. In Select effective zone screen, drag and select the area that wants to be tracking (a blue frame will show on screen). To re-select the area, just drag and select another wanted area.
4. Click **"Save"** to save the setting.



Setup Shielded Zone

Define the area that user doesn't want camera to track. The shield zone should be within the active zone. 8 shield zones can be set.

[Note] The screen of shield zone setting is based on panoramic camera view.

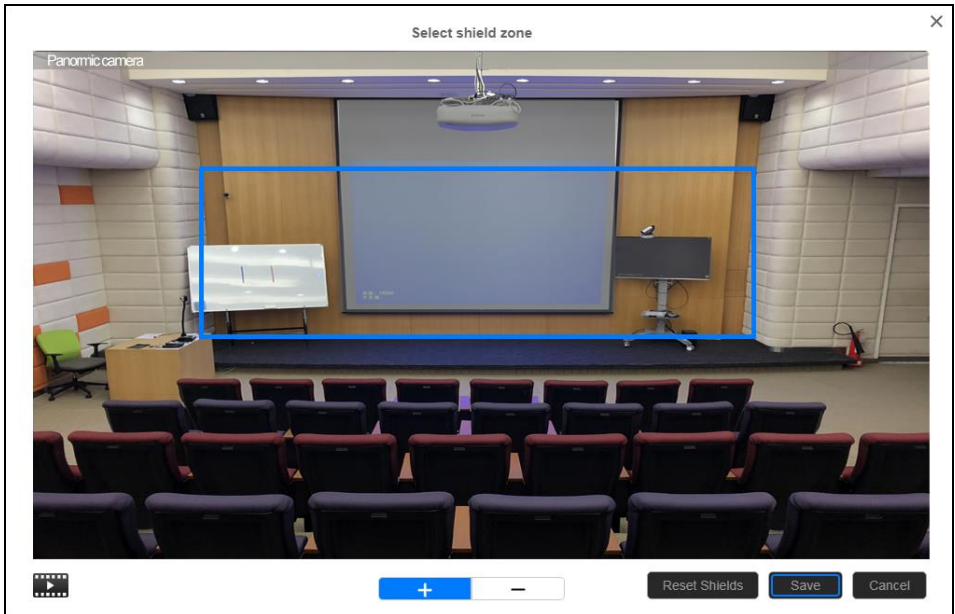

1. Select  > **Tracking setting** > **Stage** > **Select shielded zone**.
2. An online tutorial will display. User can watch to learn how to setup shield zone. Click **Skip** to stop tutorial. To watch again, select  to play online tutorial.
3. In Shielded tracking zone screen, click the “+” and select the area in tracking zone that don't want to be tracking (a gray block will show on screen). For example: Shielded the projector screen and TV that may influence the tracking. To delete the shield zone area, click “-” and select the shield to delete it. Or select “**Reset Shields**” to delete all shields.
4. Select “**Save**” to save the setting.



Setup Target Tracking Body

Define the width of tracking target. 1 target zone can be set.

[Note] The screen of target tracking body is based on panoramic camera view.

1. Select  > **Tracking setting** > **Stage** > **Select target tracking body**.
2. An online tutorial will display. User can watch to learn how to setup tracking zone. Click **Skip** to stop tutorial. To watch again, select  to play online tutorial.
3. In select target tracking body screen, drag and set the width of object that wants to be tracked (an orange frame will show on screen). To re-set the width of object, just drag again.
4. Click "**Save**" to save the setting.

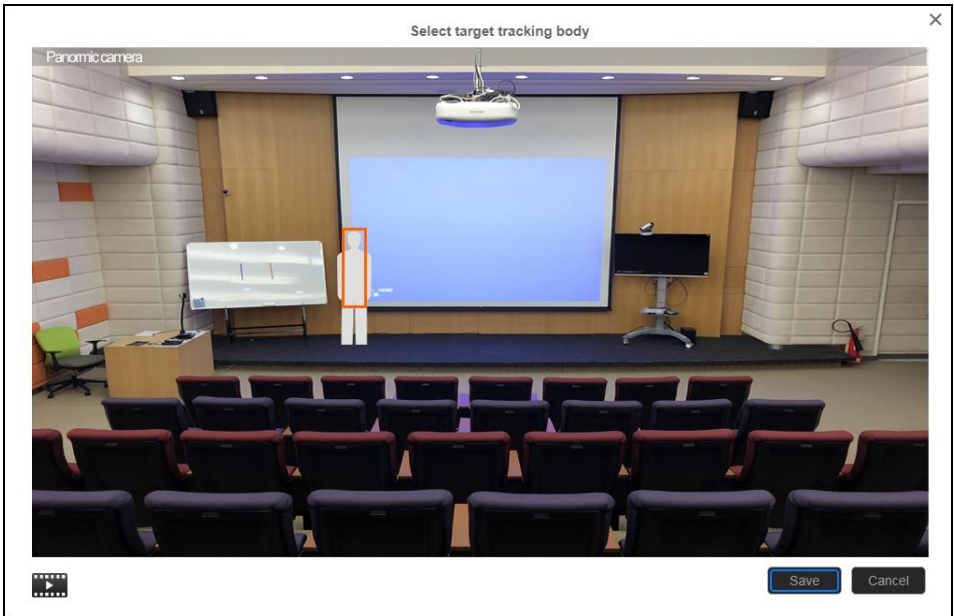

Segment Mode

The PTC500S will start tracking when object is moving between the blocks.

Setup Effective Zone

If PTC500S detects motions in the defined zone and PTC500S will be triggered to track. If effective zone doesn't setup, then, all the panoramic view will be the default active zone. The effective zone can be defined from 2 to 4 blocks.

[Note] The screen of effective zone setting is based on panoramic camera view.

1. Select  > **Tracking setting** > **Segment** > **Select effective zone**.
2. Drag a tracking area on screen (blue frame). Then, click **"Next"** button.

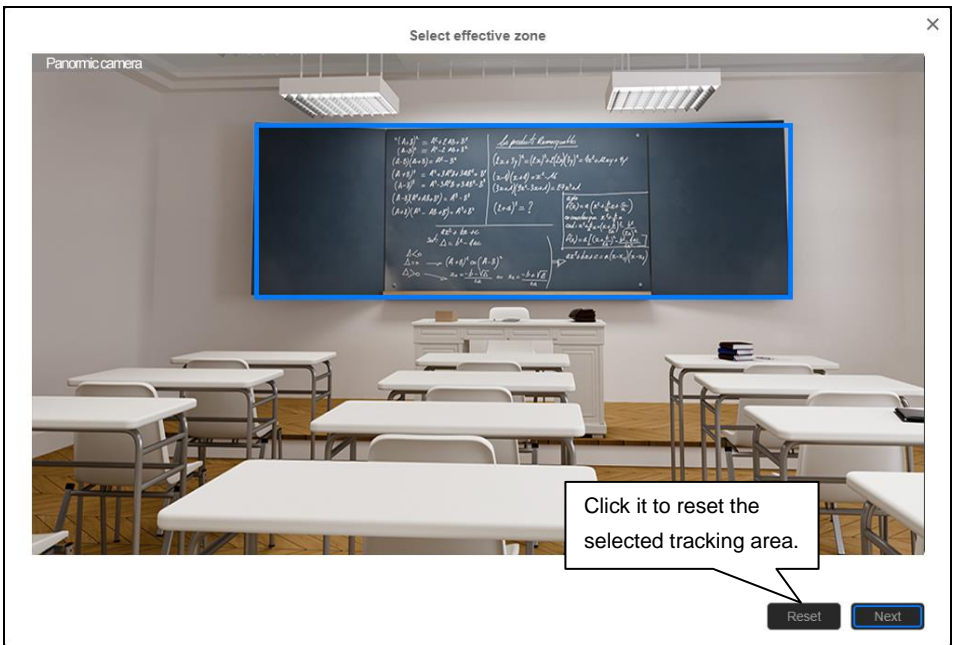

3. Select the tracking zone blocks – 2, 3, or 4 blocks. At least 2 blocks must be set.

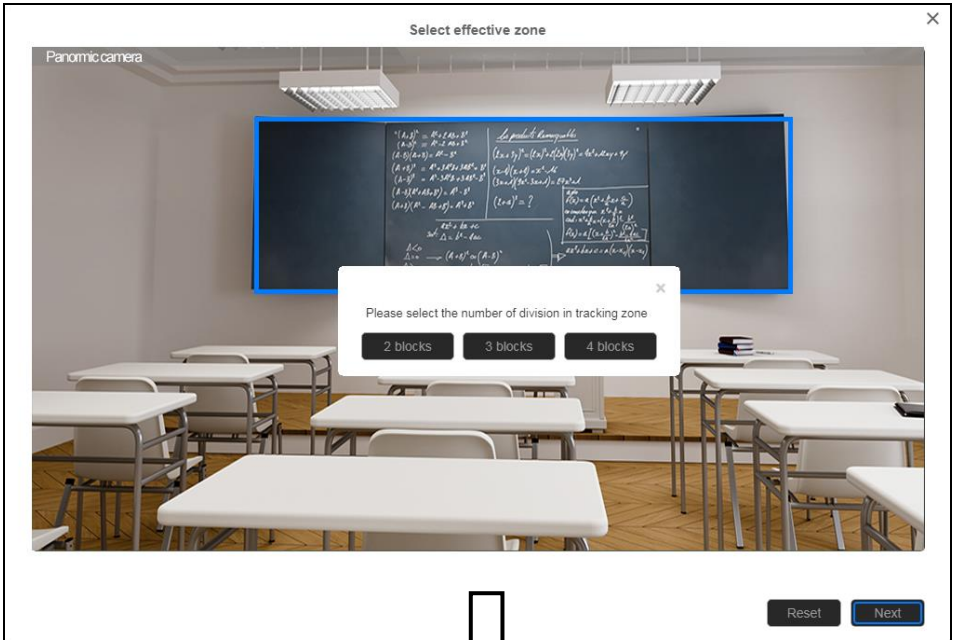

Click on the edge (left & right) to adjust block size.

Make an **overlap area** between blocks to avoid the camera move frequently at junction point.

Click the preset button to adjust block size.

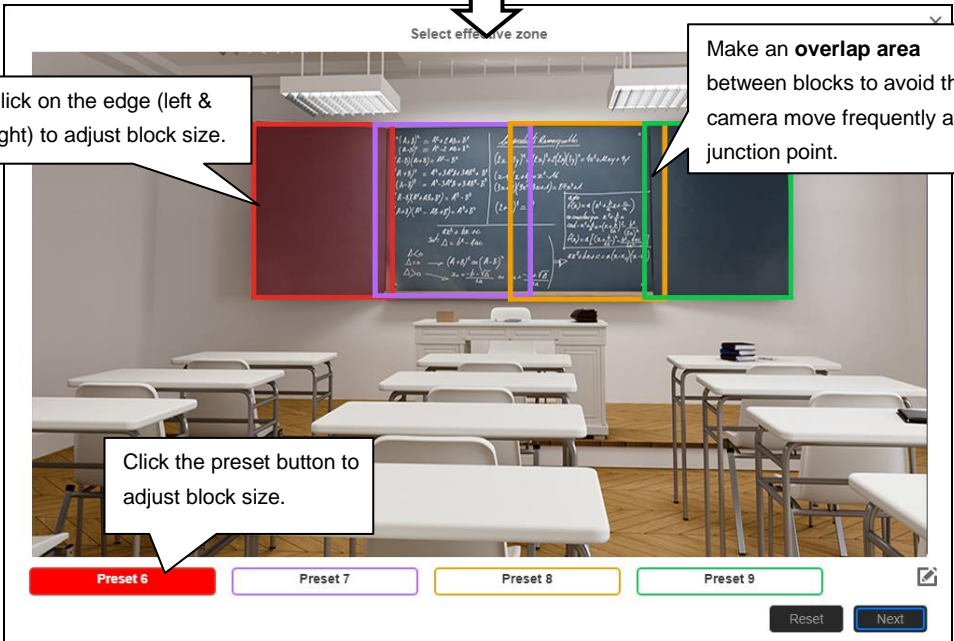

- Click **"Next"** to set the position of tracking zone. Click preset button and use ▲, ▼, ◀, ▶, Zoom +/- to adjust to the desire position. When each time preset position is set, click **"Save"** to save the settings.

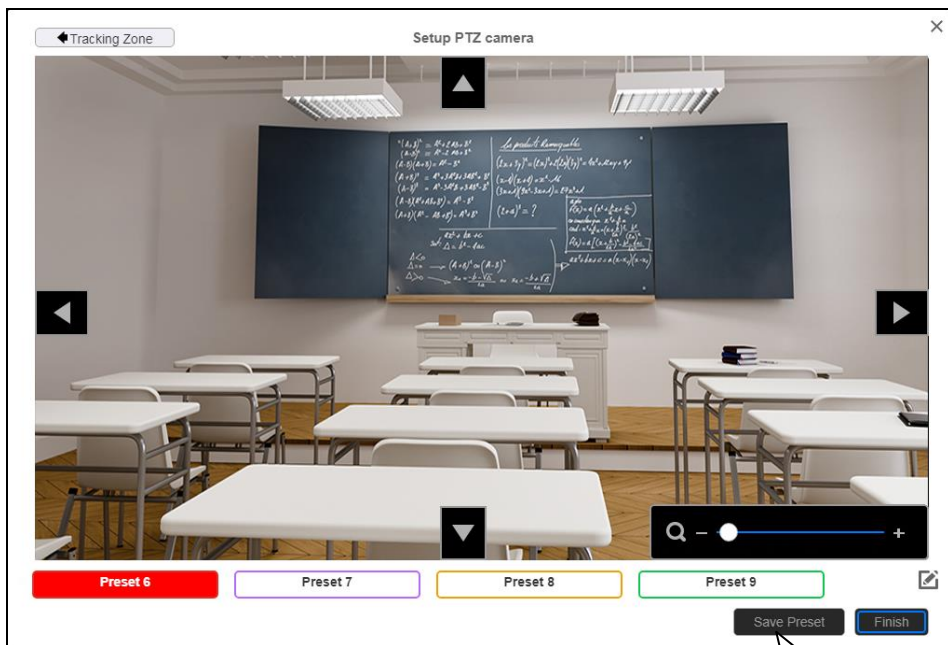



- Click **"Finish"** to complete the settings.

When each time preset position is set, click **"Save"** to save the settings.

Setup Shielded Zone

Define the area that user doesn't want camera to track. The shield zone should be within the active zone. 8 shield zones can be set.

[Note] The screen of shield zone setting is based on panoramic camera view.

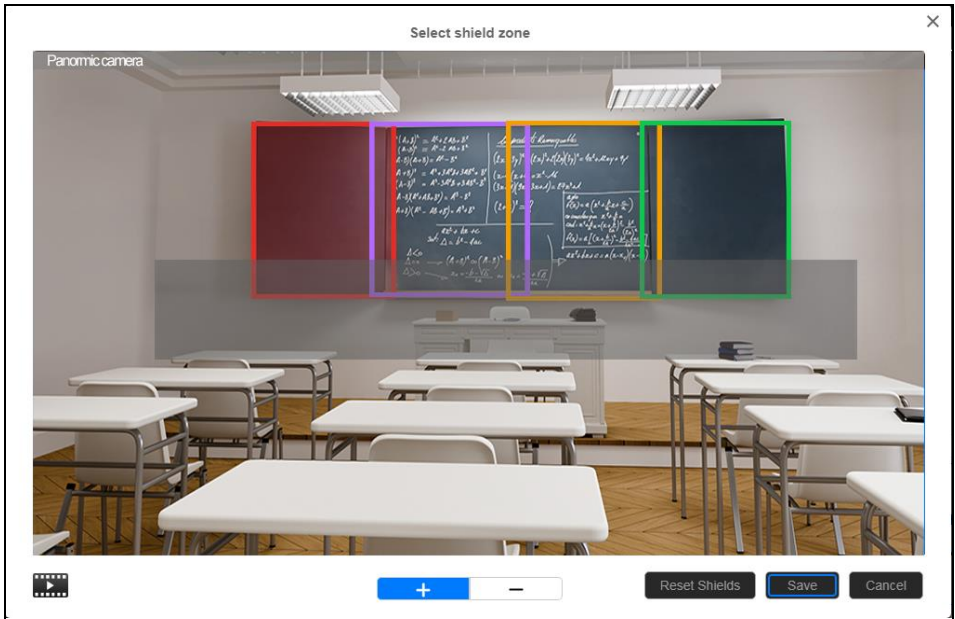

1. Select  > **Tracking setting** > **Segment** > **Select shielded zone**.
2. An online tutorial will display. User can watch to learn how to setup shield zone. Click **Skip** to stop tutorial. To watch again, select  to play online tutorial.
3. In Shielded tracking zone screen, click the **+** and select the area in tracking zone that don't want to be tracking (a gray block will show on screen). For example: Shielded first row of student that may influence the tracking. To delete the shield zone area, click **-** and select the shield to delete it. Or select **Reset Shields** to delete all shields.
4. Select **Save** to save the setting.



Setup Target Tracking Body

Define the width of tracking target. 1 target zone can be set.

[Note] The screen of target tracking body is based on panoramic camera view.

1. Select  > **Tracking setting** > **Segment** > **Select target tracking body**.
2. An online tutorial will display. User can watch to learn how to setup tracking zone. Click **Skip** to stop tutorial. To watch again, select  to play online tutorial.
3. In select target tracking body screen, drag and set the width of object that wants to be tracked (an orange frame will show on screen). To re-set the width of object, just drag again.
4. Click **“Save”** to save the setting.

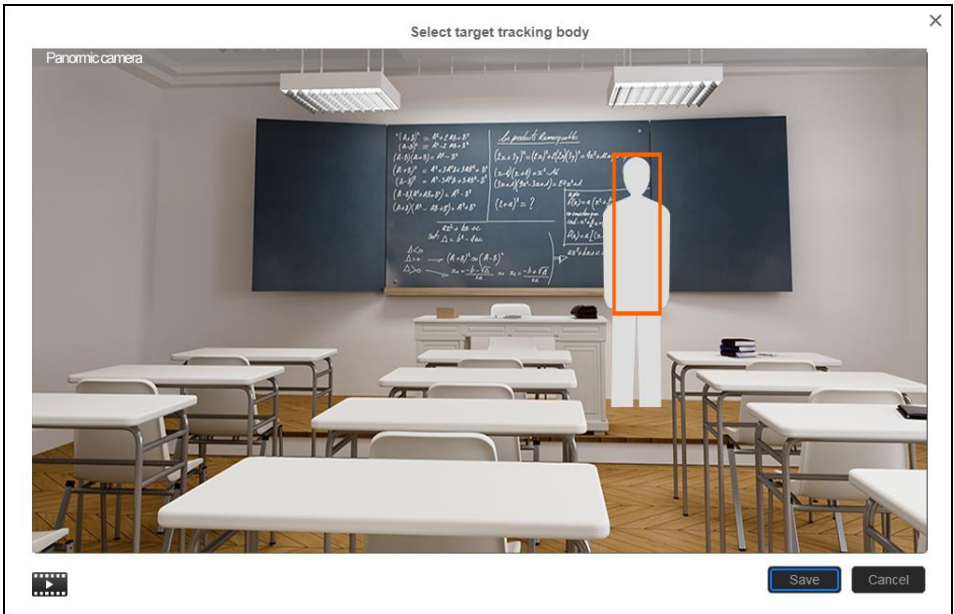

Preset Setup

Define the specific location to view when select preset number (1~255). **When PTC500s lose tracking, it will back to the preset 1 position.**

1. Open the browser and enter the IP address of PTC500S to login to PTC500S.
2. Select  > **Preset Setting**.
3. Use the direction control panel to adjust the PTC500S to desired position.
4. Next, select the preset number in “**Save to Preset**” column and click “**Save**” button to save the preset.

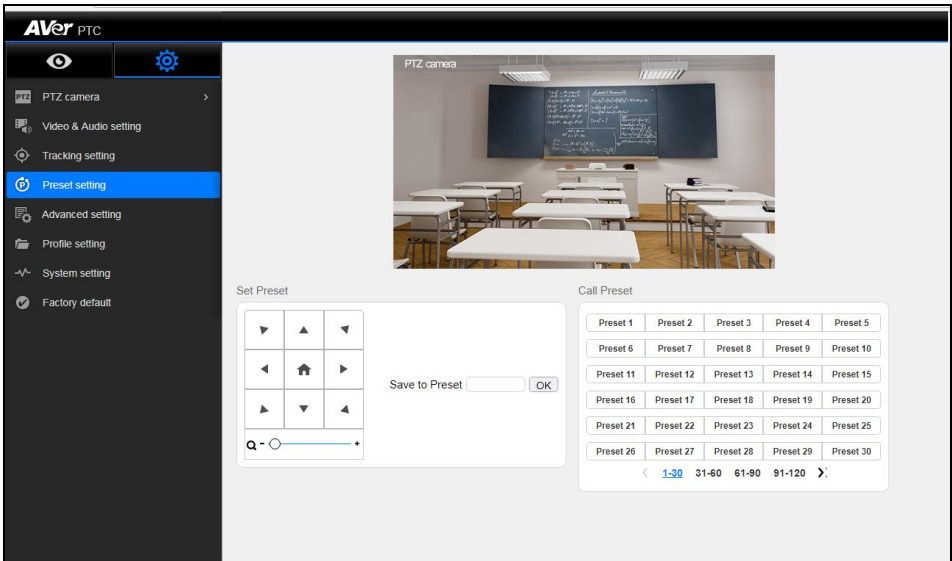

5. Select preset number in Call Preset section can view preset position view.
6. After call preset, the tracking will be off. Remember to **turn on the tracking** manually. Or press  on remote controller.

Firmware Update

1. Download the newest firmware from <http://www.aver.com/download-center>.
2. Connect to camera through browser.
3. Select **System > Firmware > Upgrade firmware > Upgrade**.
4. Select the firmware and select “**Upload**” button.
5. After updating, refresh the browser.

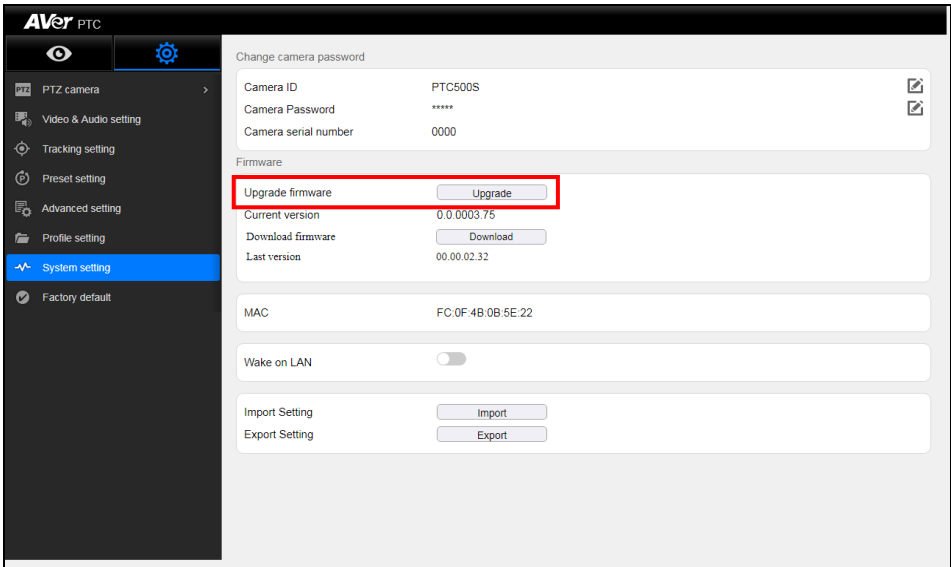

Using RTSP connect to Camera

Use RTSP player connecting to camera; please enter the following RTSP URL in your application such as VLC, PotPlayer, or QuickTime.

PTZ camera: rtsp:// IP address of PTC500S:554/live_st1

For example: rtsp://192.168.1.1:554/live_st1

Panoramic camera: rtsp://IP address of PTC500S:8554/live_st2

For example: rtsp://192.168.1.1:8554/live_st2



OSD SETUP

Before You Begin

Make sure all connections are connected successfully before using the PTC500S. Connections error will cause no image showing or no reaction. (For more information, please refer to INSTALLATION chapter.)

For the First Time Use

Trigger OSD Menu

Press  button on remote controller to call out OSD menu. Use **▶** to enter sub-menu, use **▲** and **▼** to move to the selection and use  to confirm the selection. Press **◀** button can back to previous level of menu.

1	Blue text indicates the current selection.
2	“>” means has sub-menu or value selection.
3	Sub-menu
4	Column for enter value or value selections.

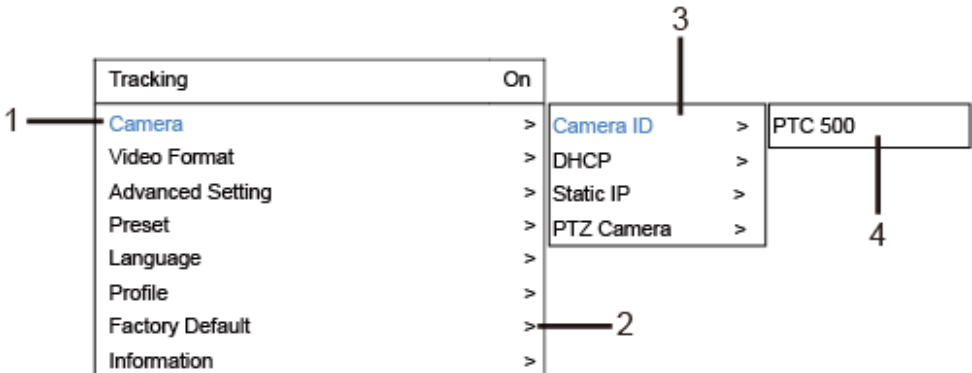





Setup IP Address

Setup IP address of PTC500S.

There are two ways to setup IP address of PTC500S. Please follow the steps below to setup the IP address.

■ Static IP Address



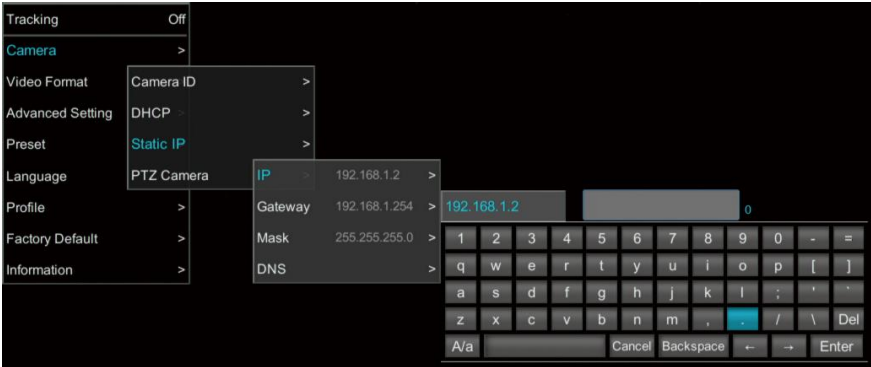

Assign a fix IP address for PTC500S.

1. After starting-up, press  button on remote control to call out OSD menu.
2. Turn the DHCP off first. Go to **Camera > DHCP > DHCP > Off** then press  or enter button to confirm the selection. The menu selection will switch to “**Static IP**” when DHCP off is applied.
3. Use , , Enter button, and on-screen keyboard to setup the “**IP**”, “**Gateway**”, “**Mask**” and “**DNS**”.



■ Dynamic IP Address(DHCP)

Get IP address from your local DHCP server.

1. After starting-up, press  button on remote control to call out OSD menu.
2. Use  and  buttons to select the **Camera > DHCP > DHCP > On**, then press  or enter button to get IP address from local DHCP server.

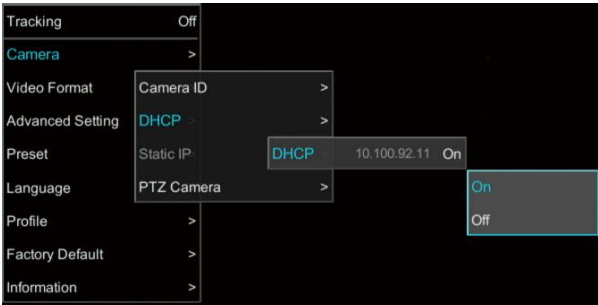

3. Use ▲ and ▼ buttons go to “**Information**” to check the IP address information.

Tracking	Off
Camera	>
Video Format	>
Advanced Setting	>
Preset	>
Language	>
Profile	>
Factory Default	>
Information	>

Camera ID	PTC500
Serial Number	0000
Firmware Version	0.0.0002.62
IP Address	10.100.93.25
MAC	FC:0F:4B:61:1F:F4

OSD Tree Map

Main

Tracking	On
Camera	>
Video Format	>
Preset	>
Advanced Setting	>
Language	>
Profile	>
Factory Default	>
Information	>

Tracking

- User can enable or disable auto-tracking.
- PTC500S will not track on object automatically when the feature is disabled.
- To enable auto-tracking, please select "On".
- To disable auto-tracking, select "Off".

Tracking	On	On
Camera	>	Off
Video Format	>	
Advanced Setting	>	
Preset	>	
Language	>	
Profile	>	
Factory Default	>	
Information	>	

Camera

In the section, users can change camera ID, network setting and adjust parameter of camera settings.

Tracking	On		
Camera	>	Camera ID	>
Video Format	>	DHCP	>
Advanced Setting	>	Static IP	>
Preset	>	PTZ Camera	>
Language	>		
Profile	>		
Factory Default	>		
Information	>		

Camera ID

To change camera ID, please select **Camera > Camera ID**.

Tracking	On			
Camera	>	Camera ID	>	PTC500S
Video Format	>	DHCP	>	
Advanced Setting	>	Static IP	>	
Preset	>	PTZ Camera	>	
Language	>			
Profile	>			
Factory Default	>			
Information	>			

DHCP

To enable DHCP, select **Camera > DHCP**.

Tracking	On			
Camera	>	Camera ID	>	
Video Format	>	DHCP	>	DHCP10.1.0.1 ON
Advanced Setting	>	Static IP	>	
Preset	>	PTZ Camera	>	
Language	>			
Profile	>			
Factory Default	>			
Information	>			

Static IP

To setup network as a static IP, select **Camera > Static IP** (Please set DHCP off before the Static IP setting)

Tracking	On		
Camera	>	Camera ID	>
Video Format	>	DHCP	>
Advanced Setting	>	Static IP	>
Preset	>	PTZ Camera	>
Language	>		
Profile	>		
Factory Default	>		
Information	>		

IP 10.1.0.1	>
Mask 255.255.0.255	>
Gateway 10.1.0.1	>
DNS	>

PTZ Camera

To adjust the parameters of PTZ camera, select **Camera >PTZ Camera**.

Tracking	On
Camera	>
Video Format	>
Advanced Setting	>
Preset	>
Language	>
Profile	>
Factory Default	>
Information	>

Camera ID	>
DHCP	>
Static IP	>
PTZ Camera	>

Camera Mode	Full Auto	>
	Full Auto	>
	Shutter Priority	>
	Iris Priority	>
	Manual	>
White Balance		>
Shading Correction		>
Pan/Tile Speed		1
Zoom Speed		Low
Digital Zoom Limit		12
PTZ Zoom Focus		Off
Power Up		Home
Frequency		Auto
Contrast		2
Saturation		5
Sharpness		Medium
NosieReduction		Medium

Camera Mode

There are 4 modes of camera mode, you can select one from **Camera > PTZ Camera > Camera Mode**.

<table border="1"> <tr> <td>Camera Mode</td> <td>Full Auto</td> <td>></td> </tr> <tr> <td>Full Auto</td> <td></td> <td>></td> </tr> <tr> <td>Shutter Priority</td> <td></td> <td>></td> </tr> <tr> <td>Iris Priority</td> <td></td> <td>></td> </tr> <tr> <td>Manual</td> <td></td> <td>></td> </tr> <tr> <td>White Balance</td> <td></td> <td>></td> </tr> <tr> <td>Shading Correction</td> <td></td> <td>></td> </tr> </table>	Camera Mode	Full Auto	>	Full Auto		>	Shutter Priority		>	Iris Priority		>	Manual		>	White Balance		>	Shading Correction		>	<table border="1"> <tr> <td>Full Auto</td> <td>></td> </tr> <tr> <td>Shutter Priority</td> <td>></td> </tr> <tr> <td>Iris Priority</td> <td>></td> </tr> <tr> <td>Manual</td> <td>></td> </tr> </table>	Full Auto	>	Shutter Priority	>	Iris Priority	>	Manual	>	<table border="1"> <tr> <td>Slow Shutter</td> <td>Off</td> </tr> <tr> <td>Maximum Gain</td> <td>24dB</td> </tr> <tr> <td>Back Light compens</td> <td>Off</td> </tr> <tr> <td>Exposure</td> <td>0</td> </tr> </table>	Slow Shutter	Off	Maximum Gain	24dB	Back Light compens	Off	Exposure	0
Camera Mode	Full Auto	>																																					
Full Auto		>																																					
Shutter Priority		>																																					
Iris Priority		>																																					
Manual		>																																					
White Balance		>																																					
Shading Correction		>																																					
Full Auto	>																																						
Shutter Priority	>																																						
Iris Priority	>																																						
Manual	>																																						
Slow Shutter	Off																																						
Maximum Gain	24dB																																						
Back Light compens	Off																																						
Exposure	0																																						
<table border="1"> <tr> <td>Pan/Tile Speed</td> <td>1</td> </tr> <tr> <td>Zoom Speed</td> <td>Low</td> </tr> <tr> <td>Digital Zoom Limit</td> <td>12</td> </tr> <tr> <td>PTZ Zoom Focus</td> <td>Off</td> </tr> <tr> <td>Power Up</td> <td>Home</td> </tr> <tr> <td>Frequency</td> <td>Auto</td> </tr> <tr> <td>Contrast</td> <td>2</td> </tr> <tr> <td>Saturation</td> <td>5</td> </tr> <tr> <td>Sharpness</td> <td>Medium</td> </tr> <tr> <td>NosieReduction</td> <td>Medium</td> </tr> </table>	Pan/Tile Speed	1	Zoom Speed	Low	Digital Zoom Limit	12	PTZ Zoom Focus	Off	Power Up	Home	Frequency	Auto	Contrast	2	Saturation	5	Sharpness	Medium	NosieReduction	Medium	<table border="1"> <tr> <td>Full Auto</td> <td>></td> </tr> <tr> <td>Shutter Priority</td> <td>></td> </tr> <tr> <td>Iris Priority</td> <td>></td> </tr> <tr> <td>Manual</td> <td>></td> </tr> </table>	Full Auto	>	Shutter Priority	>	Iris Priority	>	Manual	>	<table border="1"> <tr> <td>Speed</td> <td>1/30</td> </tr> <tr> <td>Maximum Gain</td> <td>24dB</td> </tr> <tr> <td>Exposure</td> <td>0</td> </tr> </table>	Speed	1/30	Maximum Gain	24dB	Exposure	0			
Pan/Tile Speed	1																																						
Zoom Speed	Low																																						
Digital Zoom Limit	12																																						
PTZ Zoom Focus	Off																																						
Power Up	Home																																						
Frequency	Auto																																						
Contrast	2																																						
Saturation	5																																						
Sharpness	Medium																																						
NosieReduction	Medium																																						
Full Auto	>																																						
Shutter Priority	>																																						
Iris Priority	>																																						
Manual	>																																						
Speed	1/30																																						
Maximum Gain	24dB																																						
Exposure	0																																						
	<table border="1"> <tr> <td>Full Auto</td> <td>></td> </tr> <tr> <td>Shutter Priority</td> <td>></td> </tr> <tr> <td>Iris Priority</td> <td>></td> </tr> <tr> <td>Manual</td> <td>></td> </tr> </table>	Full Auto	>	Shutter Priority	>	Iris Priority	>	Manual	>	<table border="1"> <tr> <td>Slow Shutter</td> <td>Off</td> </tr> <tr> <td>Iris</td> <td>F6.8</td> </tr> <tr> <td>Maximum Gain</td> <td>24dB</td> </tr> <tr> <td>Exposure</td> <td>0</td> </tr> </table>	Slow Shutter	Off	Iris	F6.8	Maximum Gain	24dB	Exposure	0																					
Full Auto	>																																						
Shutter Priority	>																																						
Iris Priority	>																																						
Manual	>																																						
Slow Shutter	Off																																						
Iris	F6.8																																						
Maximum Gain	24dB																																						
Exposure	0																																						
	<table border="1"> <tr> <td>Full Auto</td> <td>></td> </tr> <tr> <td>Shutter Priority</td> <td>></td> </tr> <tr> <td>Iris Priority</td> <td>></td> </tr> <tr> <td>Manual</td> <td>></td> </tr> </table>	Full Auto	>	Shutter Priority	>	Iris Priority	>	Manual	>	<table border="1"> <tr> <td>Maximum Gain</td> <td>24dB</td> </tr> <tr> <td>Speed</td> <td>1/30</td> </tr> <tr> <td>Iris</td> <td>F6.8</td> </tr> </table>	Maximum Gain	24dB	Speed	1/30	Iris	F6.8																							
Full Auto	>																																						
Shutter Priority	>																																						
Iris Priority	>																																						
Manual	>																																						
Maximum Gain	24dB																																						
Speed	1/30																																						
Iris	F6.8																																						

White Balance

To adjust white balance value, select **Camera > PTZ Camera > White Balance**.

Camera Mode	Full Auto	>
	Full Auto	>
	Shutter Priority	>
	Iris Priority	>
	Manual	>
White Balance		>
Shading Correction		>
Pan/Tile Speed		1
Zoom Speed		Low
Digital Zoom Limit		12
PTZ Zoom Focus		Off
Power Up		Home
Frequency		Auto
Contrast		2
Saturation		5
Sharpness		Medium
NoisieReduction		Medium

Mode	Auto
------	------

Auto	
One Push	
Manual	6247

Shading Correction

To adjust shading correction, select **Camera > PTZ Camera > Shading Correction** (The option is for the screen corner shadow fixing.)

Camera Mode	Full Auto	>		
	Full Auto	>		
	Shutter Priority	>		
	Iris Priority	>		
	Manual	>		
	White Balance	>		
	Shading Correction	>		
Pan/Tile Speed		1	Upper Left	Off
Zoom Speed		Low	Upper Right	Off
Digital Zoom Limit		12	Bottom Left	Off
PTZ Zoom Focus		Off	Bottom Right	Off
Power Up		Home		
Frequency		Auto		
Contrast		2		
Saturation		5		
Sharpness		Medium		
NosieReduction		Medium		

Video Format

To adjust Video Format, select **Video Format** from OSD menu.

Tracking	On		
Camera	>		
Video Format	>		
Advanced Setting	>	3G-SDI1/HDMI	Auto
Preset	>	3G-SDI2	Auto
Language	>	PIP	0
Profile	>		
Factory Default	>		
Information	>		

PIP Mode

Select picture-in-picture(PIP) mode. To turn off the PIP mode, select mode 0.

Tracking	On
Camera	>
Video Format	>
Advanced Setting	>
Preset	>
Language	>
Profile	>
Factory Default	>
Information	>

3G-SDI1/HDMI	Auto
3G-SDI2	Auto
PIP	0

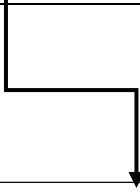

0 Turn off PIP mode

Select a layout

 1	 3	 5	 7
 2	 4	 6	 8

Advanced Setting

To adjust RS232 protocol, address and baud rate, select **Advance Setting** from OSD menu.

Tracking	On
Camera	>
Video Format	>
Advanced Setting	>
Preset	>
Language	>
Profile	>
Factory Default	>
Information	>

RS232 Protocol	VISCA
Address(ADDRD)	1
Baud Rate	9600
VISCA-over-IP	off

Preset

PTC500S allows you to set 10 preset locations via remote controller.

■ To set up preset point:

1. Enter OSD and turn off the tracking function.
2. Move camera to the prefer location and zoom distance.
3. Press  bottom > **Preset** > **Set** and use arrow key to assign a preset number and press enter button on remote controller.

[Tip] Shortcut of setting a preset location as following:

Hold on the “P” button until the message shows up. Then, press number you want to set, ex: 1 and press enter.

Tracking	On
Camera	>
Video Format	>
Advanced Setting	>
Preset	>
Language	>
Profile	>
Factory Default	>
Information	>

Set	1
Call	1

■ To call a preset location:

Press  bottom > **Preset** > **call** and use arrow key to select which preset number you would like to recall -> press enter button on remote controller.

[Tip] Shortcut of calling a preset location: press “**P**” > press number you want to recall, ex: 1.

Language

To change language, go to **OSD menu > Language.**

Tracking	On	
Camera	>	
Video Format	>	
Advanced Setting	>	
Preset	>	
Language	>	English
Profile	>	繁體中文
Factory Default	>	簡體中文
Information	>	日本語
		Deutsch
		Francais
		Espanol
		한국어
		Vietnamese

Profile

PTC500S allows you to save 5 profiles.

To set the profile, go to OSD menu > **Set** and use arrow key to assign a number and press enter button.

To call the profile, go to OSD menu > **Apply** and use arrow key to call an assigned number and press enter button.

Tracking	On	
Camera	>	
Video Format	>	
Advanced Setting	>	
Preset	>	
Language	>	
Profile	>	
Factory Default	>	Set default
Information	>	Apply default

Factory Default

To reset the PTC500S to default setting, go to OSD menu > **Factory Default** > **Yes** and press enter button.

Tracking	On
Camera	>
Video Format	>
Advanced Setting	>
Preset	>
Language	>
Profile	>
Factory Default	>
Information	>

Yes
No

Information

To check out information on the PTC500S, ex: FW version. Go to OSD menu > **Information**.

Tracking	On
Camera	>
Video Format	>
Advanced Setting	>
Preset	>
Language	>
Profile	>
Factory Default	>
Information	>

Camera ID	PTC500
Serial Number	0000
Firmware Version	0.0.0002.12
IP Address	10.1.0.1
MAC	FB:5F:4B:61:1F:4F

Hot Key

Press certain button on remote controller to perform hot key function.

Button	Action	Function
	Press and hold(3secs)	Power on/off camera. [Note] Only support at PTC500S FW version 0.0.1000.08 and above.
3	Press three times(333)	Enable/Disable tracking function When the hot key takes effect, you will see “tracking on” or “tracking off” on the right bottom side.
6	Press six times(666666)	Enable/Disable AVer Logo When the hot key takes effect, you will see “AVer” logo on the right bottom side.
7	Press seven times(7777777)	Show the tracking indicator When the hot key takes effect, you will see the tracking indicator on the target face.
8	Press eight times(88888888)	Set PTC500S IP address as default IP(192.168.1.168.)
9	Press nine times(999999999)	Password Reset mechanism: When the hot key takes effect, the password of entering Web UI will go back the default “admin”.

FAQ

1. How to define the zoom level of tracking target?

It's determined by Setup Object Viewing Dimension. You should stand on the assigned location as a proportional scale and zoom in/out to the proportion that you want. The following tracking will be based on this proportion.

2. How preset 1 has influence in the tracking settings?

When tracking cam loses the target, the position camera will go back to preset1.

3. How does tracking work in Wide Area mode?

When object enters the priority zone, PTZ camera will move to the position of object and do the face detection. After face is detected, PTZ camera will start tracking object in all area.

4. How does tracking work in Segment mode?

The tracking operation only works inside the effective zone. When object is outside of the effective zone, the camera will stop tracking object.

5. How to avoid it start tracking other person in the same area?

It's hard to do it. The algorithm is based on what the camera sees. It is not intelligent enough to judge who should track or not if 2 or more persons are in the active zone. It will randomly choose one to track.

6. Will tracking be lost when we use PTC500S in a situation which the projector is turned on?

Yes, it might happen in "Wide Area mode". But we suggest to use "Stage mode" when the projector is turned on. Stage mode can be used for any lighting conditions.

7. What is the definition of HOME position?

Home is the default position after camera booting. User can define position after camera booting in below WebUI PTZ > PTZ > power up ACT.

8. What about Preset 2 ~9 are used for anything related to tracking?

If you turn off tracking, PTC500S is a regular PTZ. User can manipulate it to assign position via center control system command. The other presets are these usages.

9. This camera supports several profiles; does each profile have a different PRESET1?

Each profile has its own preset definition.

10. If we want to stop tracking and will to focus on specific location, how should I do?

Press "P" and the preset number. The camera will go to the assigned location.

11. In Wide area mode, I already masked the areas that might have something like president photo or something similar to human, but why the camera is still attracted to these areas.

The shielding zone is only for motion shielding. In a complicated environment, we suggest to use stage mode to overcome it.