

The best way to create and share ideas

LG Interactive Digital Board

TR3E/TC3D Series





As the use of digital devices increases and digitalized working becomes more and more common, multiple people in different places are working together to solve problems and make important decisions. As these tasks become more complex and difficult, collaborative meetings have become a key to success for businesses. The Interactive Digital Board (IDB) has been developed as a means of maximizing the effectiveness of such meetings, aiming to reduce spending time and costs unnecessarily. The use of IDB will be extended beyond general business meeting rooms to various places such as fashion design offices, hospitals, military command centers, and architectural offices.

Why LG Interactive Digital Board?

The LG Interactive Digital Board (IDB), powered by IDB app, is the optimal solution to meet the requirements of all spaces where meetings might take place. It facilitates a successful meeting by driving participants to freely submit their ideas on the screen using the intuitive touch and writing tools, as well as increasing their engagement thanks to superb connectivity and high readability.



Experience Intuitive Touch and Writing

- The most advanced touch technology enables intuitive and precise touch responses
- The embedded writing application is an optimized tool for writing directly onto the board

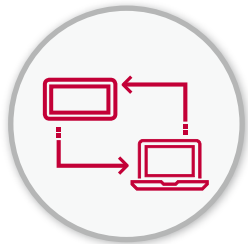

Facilitate Efficient Collaboration Without a PC

- The webOS smart signage platform makes it possible to collaborate without the need for a PC based on its high performance
- The embedded IDB app enhances the optimized work-flow for efficient collaboration



Ensure the Best Picture Quality

- Ultra HD resolution presents details clearly and without distortion even in zoom mode, resulting in clear images
- The LG IPS panel provides a wide viewing angle with accurate colors, no matter where attendees are in the meeting room



Maximize User Convenience

- User-friendly design and functions help participants to maintain full concentration in meetings by minimizing unnecessary processes and ensuring a comfortable environment

Experience Intuitive Touch and Writing

With the most advanced built-in touch technology, LG's TC3D/TR3E series enables precise screen touch responses and a sleek design.

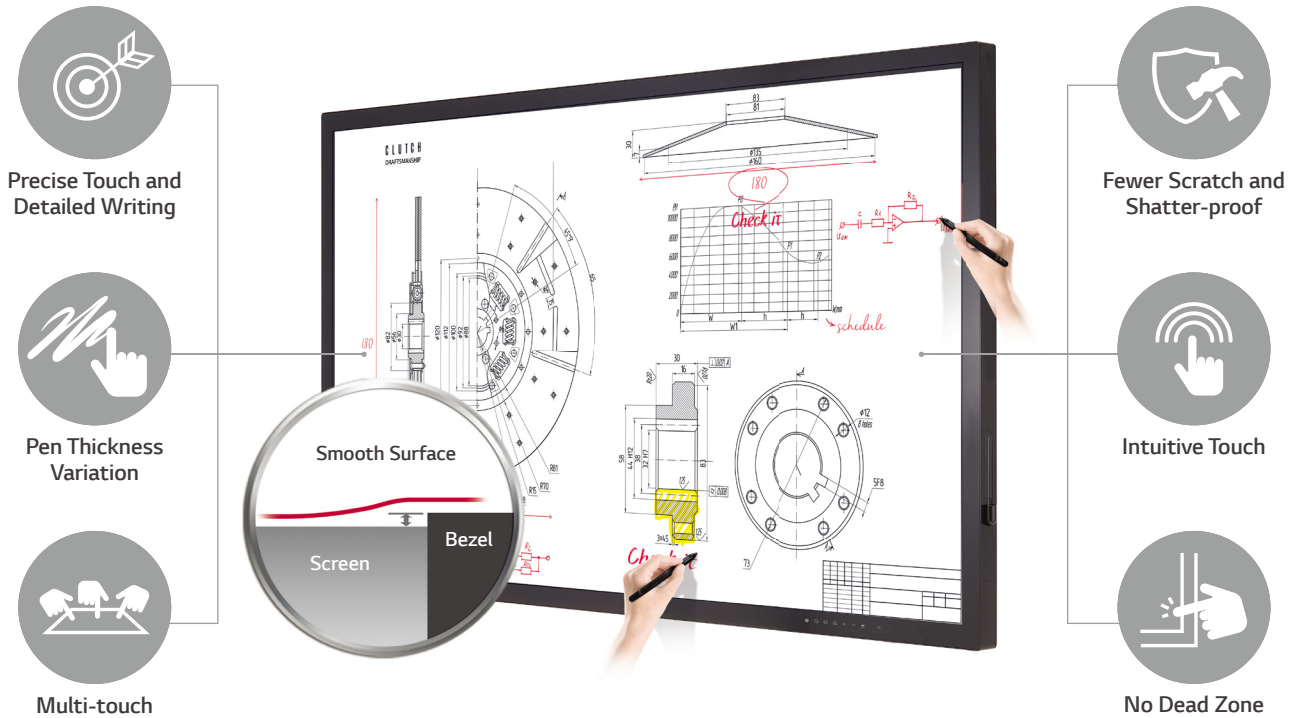

Outstanding Touch Performance

- Precise Touch and Detailed Writing**

The screen recognizes even the smallest touch points accurately and instantly shows the response to the touch point. This kind of accuracy and granularity means that users can use IDB both as a realistic handwriting tool and for detailed complex content such as drawings.

- Pen Thickness Variation**

The thickness of the pen can be adapted to the user's writing speed, even when using the passive pen. Lines or characters become bolder as the writing speed increases. This makes users feel as if they are writing on paper using their usual ballpoint pen.

- Multi-touch**

It allows multi-touches from 20 points (TR3E) to 40 points (TC3D) so that multiple participants can simultaneously use touch features.

- Smooth Surface**

As there is no need for sensors on the bezel, little or no gap space is required between the screen and bezel, allowing for more intuitive operation and a better design.

- Fewer Scratches and Shatter-proof**

When a user touches a screen directly, this can result in scratches on the screen or even damage to the glass. LG IDB has an advanced tempered screen coating to minimize scratches*. In addition, its anti-shatter glass is designed to minimize harm to the user, even in the event of an external shock.

- Intuitive Touch**

Users will find the IDB easy to use because the touchscreen feels similar to their mobile phones or tablets.

- No Dead Zone**

Unlike IR touch screens, the display detects touch points even at the corner or edge of the display accurately.

* The use of an LG magnetic stylus pen is highly recommended.

Experience Intuitive **Touch and Writing**

With the most advanced built-in touch technology, IDB app supports a comfortable writing experiences.

Easy Operation



• Open

The pre-stored files* are easy to open on the screen with a simple touch.



• Palm Erase

Writers can freely take a note and easily erase it with their palm as they do when using a conventional whiteboard. *TR3E Only



• Screen Capture & Storage

The written materials can be captured and automatically saved, which is useful when discussed content need to be stored by stages.

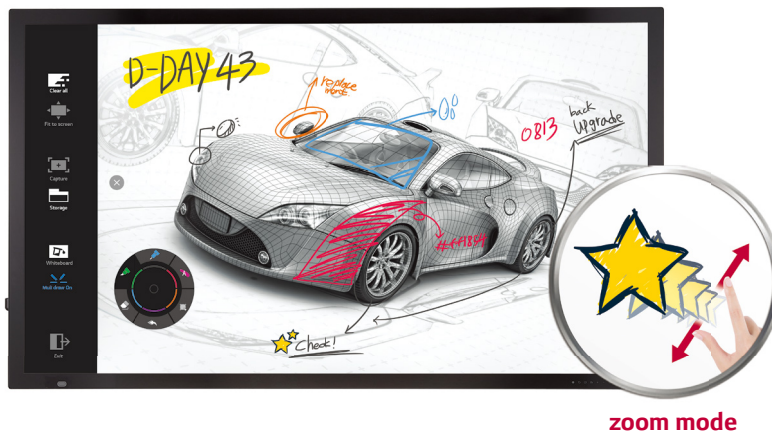

zoom mode

Floating Tool Bar

While using the writing function in IDB app mode, the user can place a floating toolbar anywhere on the screen by pressing and holding a touch point. Users can also drag it around using their fingertip or open and minimize it with a single tap, enabling comfortable and intuitive writing on the screen. Its special circular design helps users easily adopt and explore all features, even when trying the function for the first time.

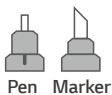

Pen Marker



Allows users to choose between a pen or marker for different levels of thickness in drawing, as well as different colors**.



Select

Allows users to adjust the size of an object or change its location by clicking on it.



Highlighter



Allows users to highlight certain information on the screen.



Undo

Allows users to undo the most recent action performed.



Eraser

Allows users to erase drawings and control the thickness of the eraser.

* PDF files created using IDB can only be opened.

**The black color is changed to white when the screen becomes blackboard.

Facilitate Efficient Collaboration Without a PC

IDB app makes it possible to collaborate without the need for a PC based on the webOS smart platform. Also, it is a complete way to enhance collaboration efficiency during a meeting, by combining whole processes which includes file sharing, writing, and saving on LG IDB.

No Need For a PC

LG webOS is powered by high-performance SoC and can execute several tasks at the same time without the need for a separate media player or PC. Especially when combined with the IDB app, the LG IDB offers both interactive collaboration as well as an intuitive writing application, meaning additional licenses for IDB solution are not required.

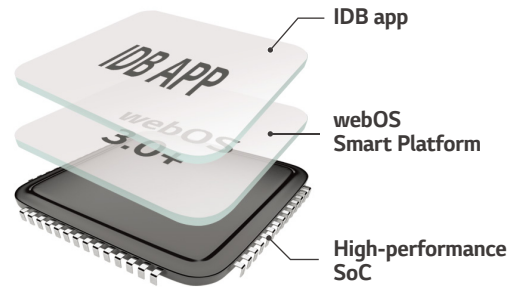

Optimized Work-flow for Efficient Collaboration

The LG IDB app provides users with a convenient and effective meeting experience beyond expectation. Incredibly, a virtual meeting space can be created in the IDB, with participation access limited to users who enter a pin number generated by the IDB. Once the participants are in, the meeting session is ready to start.

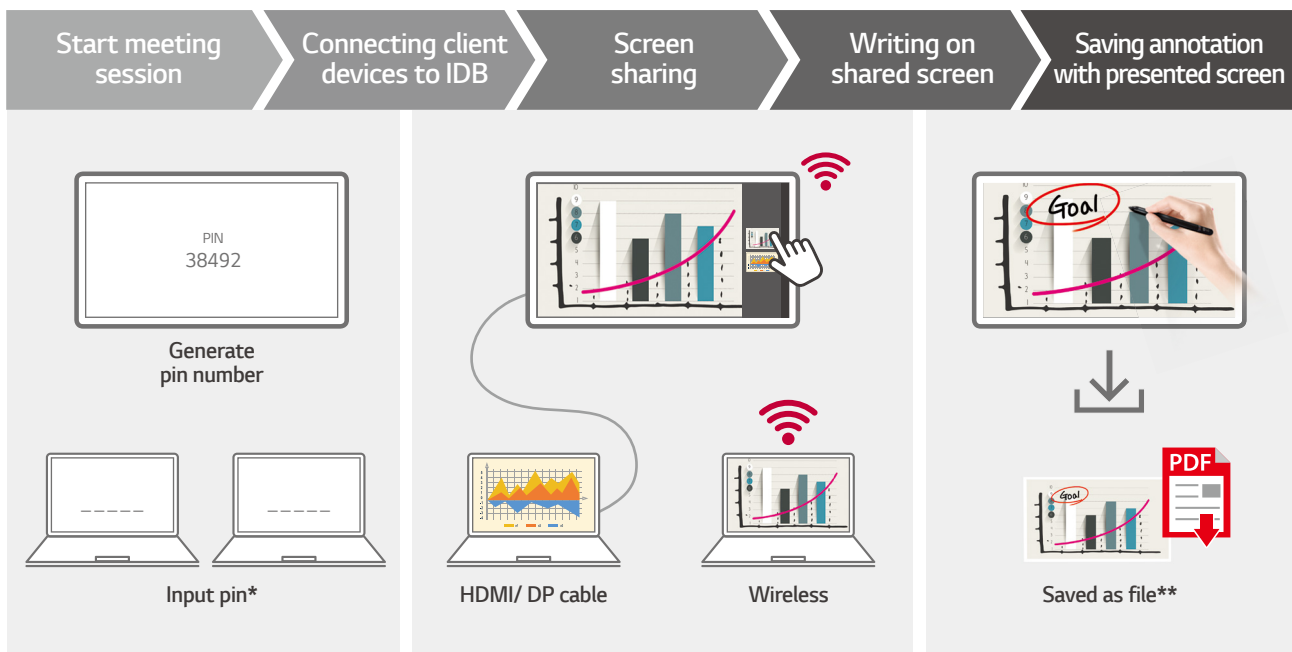

Drawing Overlay on top of HDMI/DP and Save

HDMI or DP cables are still preferred among users when connecting their digital devices to IDB. LG IDB enables screen sharing using these cables. Shared screens are shown on a list on the IDB, so that a presenter can select the desired material to be displayed in full screen mode. Also, the presenter can write notes on the shared screen and save the notes with the screen, which reduces unnecessary time spent wrapping-up or announcing meeting minutes.



Annotate on Mirrored Screen and Save

The whole process mentioned above is also available using wireless connection. The only difference is that screens can be shared with an IDB via wireless connection. Whether using cables or wireless connection, all mirrored screens are shown as a list on the IDB, so the presenter is able to choose from among them. LG IDB will be key to building an environment optimized for both efficient collaboration and effective meetings.

* The IDB Duo (client app) needs to be installed for full compatibility. Please visit www.lg.com/IDB to download the software.
When pairing devices with IDB, both devices must be connect to the same network.

**Users content will be saved in a PDF format.

Ensure the **Best Picture Quality**

LG IDB provides the best picture quality regardless of content type and viewer position.

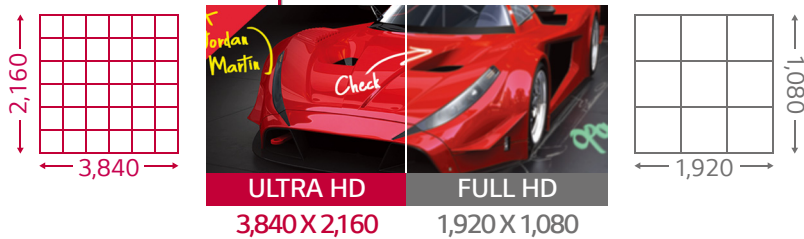

LG Ultra HD Technology with Ultra-high Resolution

IDB users often use the zoom-in function to view complex images such as design drawing in more detail or write on the presentation material. The UHD resolution of 86TR3E/75TC3D features 8.3 million pixels, which is 4 times that of FHD resolution, allowing users to view details without distortion, even when zooming in on the display. Moreover, the outstanding resolution of UHD vividly delivers high-quality images or video content to meeting attendees.

LG IPS Panel with Wide Viewing Angle and True Color

Attendees in the meeting room may view the display from a wide viewing angle. The LG IPS panel has a wide viewing angle that delivers clear content, no matter where attendees are in the room. Moreover, every pixel in the IPS panel truly reproduces the image colors without distorting them. The outstanding color reproduction provides excellent user experience for employees in design industries such as architecture and fashion.

Maximize User Convenience

LG has enhanced operability for IDB users.

Auto Signal / Touch Switching

While using the IDB, it is often necessary to connect participant's laptops so that they can share their display with others. In such cases, time is often wasted during the meeting on adjusting the external input and touch USB on the display screen. The LG IDB is designed to connect signals from the side interface first, so that a display on laptops connected to the side is immediately shown on the IDB screen and support touch functions. The original IDB display and the touch function are restored without any separate action when the laptop is disconnected from the side interface*.



NO External Input Adjustment

Editable Assistive Touch Menu

It was difficult to use the menu with the conventional IDB with large screen of 65" or more, since the setting menu could only be called from the side of the screen. The Touch Menu is a subsidiary menu introduced to eliminate such inconvenience and improve user-friendliness. LG IDB users can run the desired function or change the setting from anywhere by softly pressing the screen to call up the Touch Menu**. Moreover, it is possible to edit the menu to include preferred apps.



Touch On/Off Key

During a presentation, the touch function is not always required. In such cases, users can turn off the function just by tapping the "Assistive Menu" key. Users only need to tap this key again to turn the touch function back on. The key is on the left-hand side of the TR3E and in the lower section of the front of the TC3D series, allowing users to easily turn the touch function on/off.



Touch Off

Touch On

* Pre-setting is required to perform the restore process

** The menu design(GUI) is subject to change without notice

Maximize User Convenience

LG has enhanced operability for IDB users.

Multi Screen with PBP/PIP

PBP (Picture-By-Picture) features multi screen in a single display with upto 2 input sources, thus maximizing usability of large display. In addition, PIP (Picture-In-Picture) supports playing both main screen and sub screen at the same time with various layouts, so users can arrange many different usage scenarios efficiently.



PBP

PIP

Eye Care Support

LG IDB has several eye care features to prevent participants' eyes from growing tired during prolonged meetings. Reader mode decreases blue light, a cause of eye strain, by 70%, improving the comfort of those who are viewing the screen for a long time. Also the anti-glare coating on the screen reduces reflection for better visibility. And brightness is automatically adjusted according to ambient light of the surrounding to reduce eye strain.

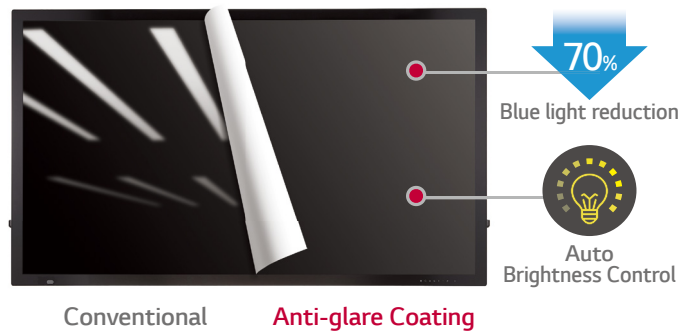

Conventional

Anti-glare Coating

High Compatibility

Compatibility is critical in meeting room environments that work with multiple devices. Especially LG IDB is compatible with AV control systems, with which users can easily manage, monitor and control LG displays from one location. Also it allows video conferencing to be held reliably, as it supports connections with VCS solutions.

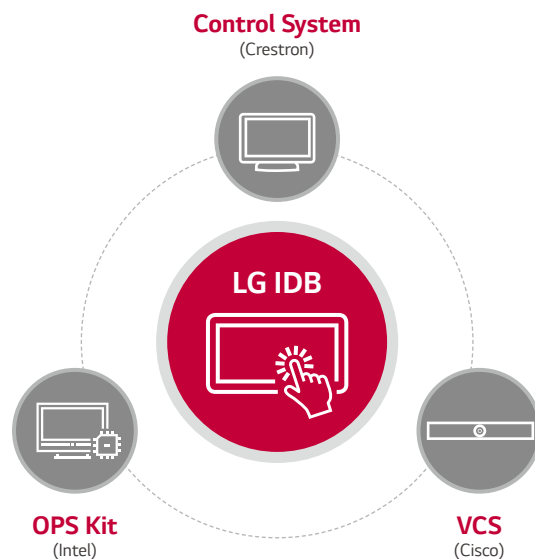

Product Information

86TR3E

Connectivity

1. HDMI	3. OPS USB 2.0
2. Touch USB	4. USB 2.0

Built-in Speaker

Magnetic Stylus Pen & Holder

Side Hot Key

1. Assistive Menu	2. IDB App
3. Reader Mode	4. Key Lock
5. Volume Up	6. Volume Down
7. Input	8. Power

75/65/55TC3D

Connectivity

1. HDMI	3. OPS USB 2.0
2. Touch USB	4. USB 2.0

Built-in Speaker

Front Hot Key

1. Assistive Menu	5. Volume
2. IDB App	6. Input
3. Reader Mode	7. Power
4. Key Lock	

Magnetic Stylus Pen & Holder

Connectivity

- | | |
|--------------|------------------|
| 1 RS232C out | 9 HDMI 2 |
| 2 RS232C in | 10 USB 3.0 |
| 3 LAN | 11 Touch USB |
| 4 RGB in | 12 HDMI 3 |
| 5 Audio in | 13 Touch USB |
| 6 DVI-D in | 14 OPS USB (2.0) |
| 7 DP in | 15 USB 2.0 |
| 8 HDMI 1 | 16 USB 3.0 |

86TR3E REAR

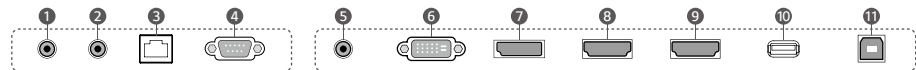

86TR3E SIDE

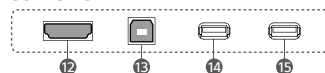

65/55TC3D REAR

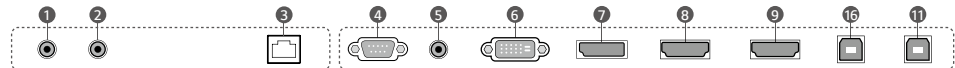

75TC3D REAR

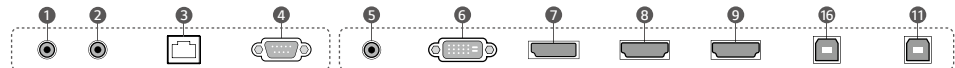

65/55/75TC3D SIDE

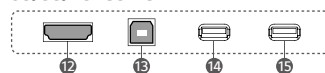

Specification





		86TR3E	75TC3D	65TC3D	55TC3D	
PANEL	Screen Size	86"	75"	65"	55"	
	Panel Technology	IPS	IPS	IPS	IPS	
	Aspect Ratio	16 : 9	16 : 9	16 : 9	16 : 9	
	Native Resolution	3,840 x 2,160 (UHD)	3,840 x 2,160 (UHD)	1,920 x 1,080 (FHD)	1,920 x 1,080 (FHD)	
	Brightness*	410 cd/m ²	500 cd/m ²	450 cd/m ²	450 cd/m ²	
	Viewing Angle (H x V)	178 x 178	178 x 178	178 x 178	178 x 178	
CONNECTIVITY	Input	HDMI (3), DP, DVI-D, RGB, Audio, USB 3.0, USB 2.0, OPS USB 2.0				
	Output	Touch USB 2.0 (2)				
	External Control	RS232C In/out, RJ45 In				
PHYSICAL SPECIFICATION	Bezel Width	50.7 mm (T/L/R), 62.2 mm (B)	41.6 mm(T/L/R/B)	36.1mm(T/L/R), 42.2mm(B)	32.7mm (T), 33.4(L/R), 38.8 mm(B)	
	Monitor Dimension (W x H x D)	2,026.9 x 1,180.3 x 79.5 mm (w/o Handle)	1,732.8 x 1011.1 x 69.7 mm (w/o Handle)	1,530.8 x 883.8 x 71.7 mm (w/o Handle)	1,276.4 x 751.9 x 63.9 mm	
	Weight (Head)	85.8 kg	74.5 kg	51kg	30.1 kg	
	Carton Dimensions (W x H x D)	2,190 x 1,470 x 371 mm	1,870 x 1,264 x 285 mm (with pallet)	1,650 x 1,035 x 228 mm	1,369 x 890 x 210 mm	
	Packed Weight	114.6 kg	94 kg	59kg	36.1 kg	
	VESA™ Standard Mount Interface	600 x 400 mm	600 x 400 mm	300 x 300 mm	300 x 300 mm	
KEY FEATURES	webOS 3.0+, Embedded IDB App, Crestron Connected® (Network Based Control), Mirroring, Soft AP, Beacon, Reader Mode, Auto Brightness Sensor, Internal Memory (64GB, System 8GB)					
SPECIAL FEATURES	Temperature Sensor, ISM Method, DPM Select, Brightness Control, PM Mode, Wake on LAN, Energy Saving, File Play with USB, 2 PIP/PBP, Built-in Wi-Fi (802.11n Combo), USB Cloning, Failover, No Signal Image					
ENVIRONMENT CONDITIONS	Operation Temperature Range	0°C to 40°C	0°C to 40°C	0°C to 40°C	0°C to 40°C	
	Operation Humidity Range	10% to 80%	10% to 80%	10% to 80%	10% to 80%	
POWER	Power Supply	100-240V~, 50/60Hz	100-240V~, 50/60Hz	100-240V~, 50/60Hz	100-240V~, 50/60Hz	
	Power Type	Built-In Power	Built-In Power	Built-In Power	Built-In Power	
	Power Consumption	Typ.	≤ 330 W	≤ 240 W	≤ 120 W	≤ 100 W
		Smart Energy Saving	≤ 200 W	≤ 170 W	≤ 85 W	≤ 70 W
	DPM	≤ 0.5 W	≤ 0.5 W	≤ 0.5 W	≤ 0.5 W	
AUDIO	Built-in Speaker	20 W (10Wx2)	20 W (10Wx2)	20 W (10Wx2)	20 W (10Wx2)	
STANDARD (CERTIFICATION)	Safety	UL / cUL / CB / TUV / KC	UL / cUL / CB / TUV / KC	UL / cUL / CB / TUV / KC	UL / cUL / CB / TUV / KC	
	EMC	FCC Class "A" / CE / KCC	FCC Class "A" / CE / KCC	FCC Class "A" / CE / KCC	FCC Class "A" / CE / KCC	
MEDIA PLAYER COMPATIBILITY	OPS Type Compatible	Yes	Yes	Yes	Yes	
SOFTWARE COMPATIBILITY	Content Management Software	SuperSign CMS	SuperSign CMS	SuperSign CMS	SuperSign CMS	
	Control and Monitoring Software	SuperSign Link	SuperSign Link	SuperSign Link	SuperSign Link	
ACCESSORIES	Basic	Remote Controller (2 Batteries Included), Power Cord, QSG, HDMI (3M), Regulation Book, Phone to RS232C Gender, Touch Pen (2ea), Eyebolt (2ea, 86TR3E Only), Touch Pen Tip (1ea, TC3D Only)				
	Optional	OPS Kit (KT-OPSA)	OPS Kit (KT-OPSA), Wall Mount (LSW640A/B)	OPS Kit (KT-OPSA)	OPS Kit (KT-OPSA), Wall Mount (LSW350A/B)	
TOUCH SPECIFICATIONS	Touch Type	InGlass™**	P-Cap (Ag Metal Mesh)	P-Cap (Ag Metal Mesh)	P-Cap (Ag Metal Mesh)	
	Available Object Size for Touch	more than Ø 3 mm	more than Ø 6 mm	more than Ø 6 mm	more than Ø 6 mm	
	Accuracy	2 mm	2 mm	2 mm	2 mm	
	Interface	USB 2.0	USB 2.0	USB 2.0	USB 2.0	
	Protection Glass Thickness	4T (Anti-glare)	4T (Anti-glare)	3.2T (Anti-glare)	3.2T (Anti-glare)	
Multi Touch Point	Max. 20 Points	Max. 40 Points	Max. 40 Points	Max. 40 Points		

* Brightness without protection glass
 ** Applied FlatFrog's InGlass™ Technology.



Download LG Commercial Display Mobile App



-  www.lg.com/b2b
-  [youtube.com/c/LGCommercialDisplay](https://www.youtube.com/c/LGCommercialDisplay)
-  <https://www.facebook.com/LGInformationDisplay/>
-  <https://www.linkedin.com/company/16235211/>

LG may make changes to specifications and product descriptions without notice.
Copyright © 2018 LG Electronics Inc. All rights reserved. "LG Life's Good" is a registered trademark of LG Corp.
The names of products and brands mentioned here may be the trademarks of their respective owners.